

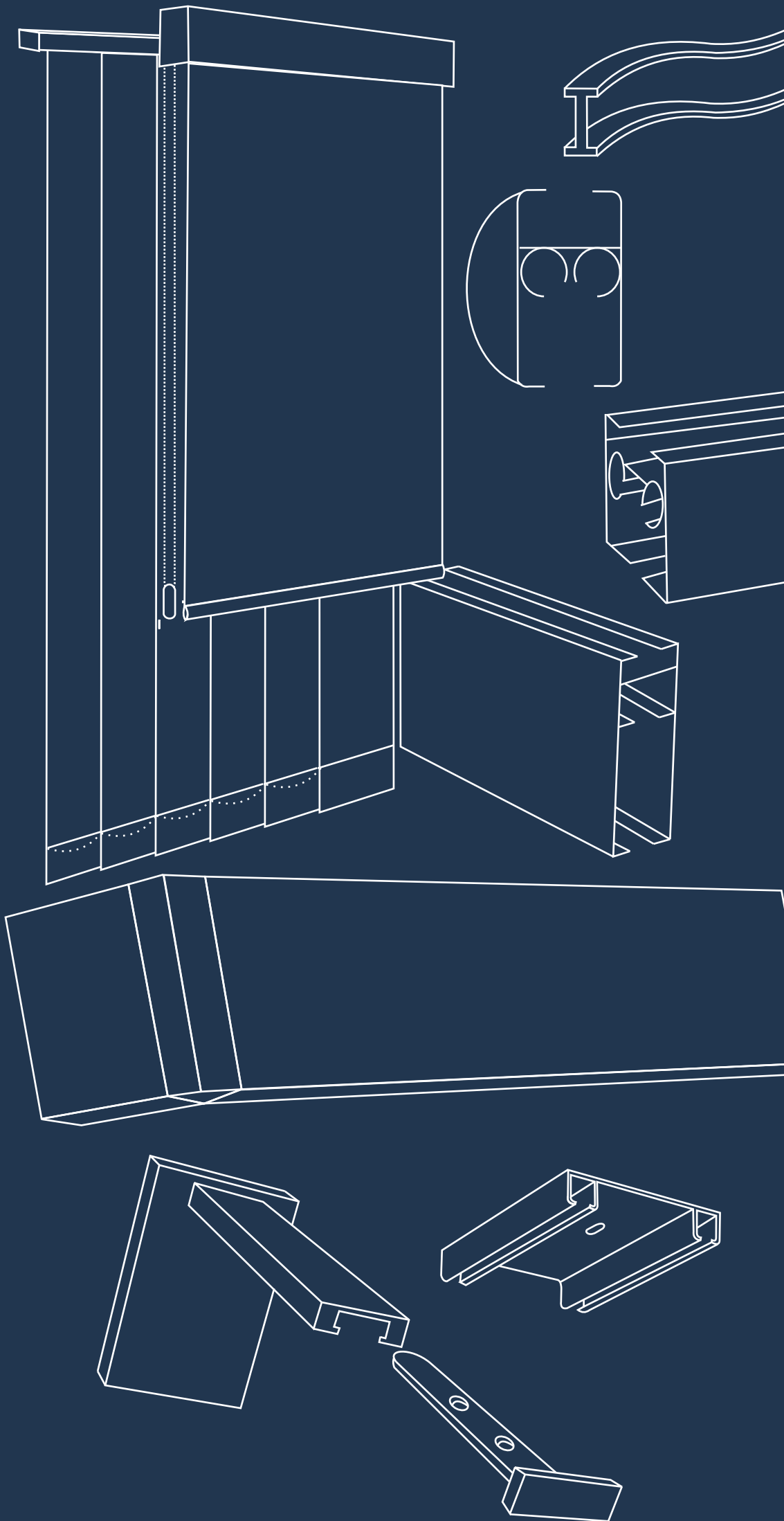

2026





CONDICIONES DE VENTA

PEDIDOS

Los pedidos se realizarán preferentemente , vía e-mail; es de máxima importancia que se indique referencia, medida, color y cantidad, esto evitara errores de manipulación y posteriores reclamaciones.

La empresa no se responsabilizará de los errores de los pedidos telefónicos.

Es imprescindible para dar de alta cualquier cliente/pedido, la SEPA de la empresa.

ENVÍO DE MERCANCÍA

La mercancía se enviará a portes pagados siempre que el pedido supere los 150 € (base imponible), el resto se cargará 12 € en concepto de portes, que se cargarán en factura. Los envíos de mercancía que exceda de 3m de longitud, serán 25 €.

El porte será siempre por la agencia que determine nuestra empresa, cualquier otro medio de transporte o agencia será siempre a cargo del cliente.

Cualquier anomalía, rotura o deterioro del embalaje a la entrega de mercancía deberán hacerlo constar en el albarán de entrega de la agencia de transportes o comunicárselo a la empresa antes de 48 horas.

PRECIOS

Debido a las fluctuaciones del mercado , los costos pueden estar sujetos a alteraciones , por lo tanto el fabricante se reserva el derecho de modificar los precios de venta previo aviso al comprador.

Los precios de tarifa son PVP (recomendados) en euros, sobre estos se les aplicará el IVA correspondiente.

RESERVA DE DOMINIO

Nuestras ventas se consideran en depósito y bajo condición de dominio, según artículo 1506 de C.C. Hasta que haya hecho efectivo íntegramente el pago total del adeudo.

RECLAMACIONES SOBRE LA MERCANCÍA

No se aceptará ninguna reclamación superado el periodo de 15 días y siempre que se comunique por escrito y referencia el albarán al que pertenece.

FORMA DE PAGO

Las acordadas con el cliente, la empresa se reserva el derecho a las modificaciones oportunas en el caso de impago o retraso en los pagos. Los pagos ocasionados por el impago serán de cuenta del cliente.

Pedidos inferiores a 50 euros: Según la forma de pago se cargarán estos importes en su factura.

Reembolso 3€

Giro 3€

Transferencia por adelantado 0€

ABONOS

No será abonada la mercancía hasta que no este en nuestras instalaciones debidamente documentada y siempre con la aceptación de la empresa.

JURISDICCIÓN

El comprador acepta en caso de desavenencia la jurisdicción de los tribunales de VALENCIA, con renuncia expresa a cualquier otro.

INDICE

Pag.5-14



Pag.35-42



Pag.15-24



Pag.43-46



Pag.25-34



Pag.47-50

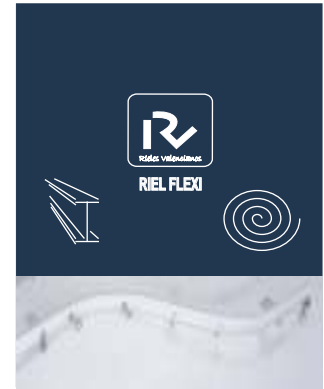

Pag.51-60

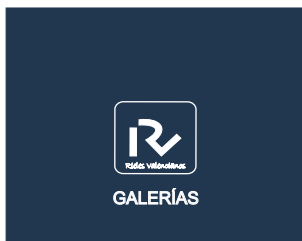

Pag.61-78

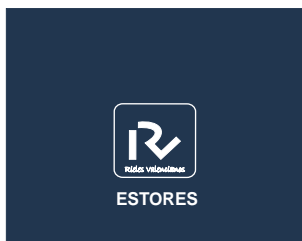

Pag.79-90

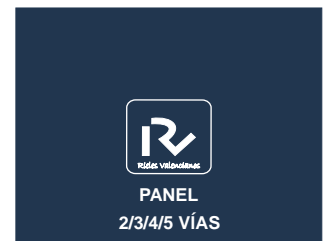

Pag.91-106

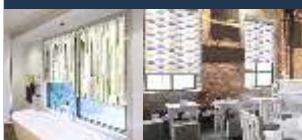

Pag.107-116



Pag.117-126



NOCHE Y DIA



A través de la presente le hacemos llegar, nuestro más cordial saludo y nuestra formal presentación.

Rieles Valencianos, somos una empresa relativamente joven, pero llevamos más de 35 años en el sector. Estamos perfectamente cualificados y buscamos garantizar la mejor predisposición y calidad de nuestro trabajo en todo momento.

Somos una empresa dedicada a la venta y distribución de todo tipo de rieles y cortina técnica. Con mucho esfuerzo hemos creado un catálogo con una amplia gama de productos para componer una gran variedad de ambientes diferentes.

Contamos con las más modernas líneas de diseño y utilizamos los mejores materiales con los que aseguramos que nuestros artículos serán de la completa satisfacción de los consumidores finales.

Tenemos una gran cantidad de existencias lo cual garantiza la disponibilidad de todos nuestros diseños combinando, calidad con los mejores precios.

Muchas gracias por su atención y estamos seguros de que en un futuro próximo, podamos colaborar estrechamente.

Atentamente,
Rieles Valencianos

Through this letter we send you our most cordial greetings and our formal introduction. We are a fairly young company but we have been the industry for more than 35 years. We are extremely qualified and we aim to guarantee the best willingness and quality work every time.

We are a new company engaged in the sale and supply of all types of rails and technical curtains. With lot of effort we have created a catalog with a wide range of products to build an extensive range of different environments.

State-of-the-art design lines and greatest materials are used to ensure the high quality of items we made warranting the complete satisfaction of final customer.

By having a huge amount of stock which guarantees the availability of all our designs, we combine quality with the best prices.

Thank you for your attention. We are looking forward to a closely collaboration in the near future.

*Kind regards,
Rieles valencianos*



RIEL DECORATIVO

14 x 40





Riel decorativo 14x40 mm

SISTEMA MONTADO A MEDIDA

ACC. MANUAL

MOD. TAPÓN



color

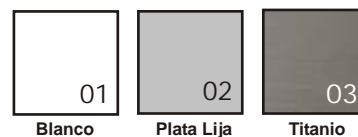

Materiales: **Aluminio**

Componentes: riel + soportes + terminales + correderas +trabador

Correderas: - Riel **standard** corredera **77001**

- Riel onda perfecta corredera **77002** (60 mm)

Instalación **TECHO** (Soporte **1217001**)

MEDIDAS EN €/cm

Corredera	Ref:	100	150	175	200	225	250	300	350	400
Standard	12181101	46	55	64	67	73	81	99	108	116
Onda perf.	12182101	51	62	72	77	84	93	114	125	135
Soportes		2	2	2	3	3	3	4	4	5

Instalación **PARED** (Standard soporte **1217006** / Onda perfecta soporte **1217007**)

MEDIDAS EN €/cm

Corredera	Ref:	100	150	175	200	225	250	300	350	400
Standard	12181201	69	78	83	103	108	116	147	155	164
Onda perf.	12182201	75	87	92	113	120	129	162	173	184
Soportes		2	2	2	3	3	3	4	4	5

Para otros soportes ver sección accesorios.

Cierre centro



Izquierda



Derecha



Es **IMPORTANTE** indicar recogido de la cortina (Onda Perfecta).

Riel Decorativo 14x40 mm



SISTEMA MONTADO A MEDIDA

ACC. MANUAL

MOD. VENTANAS - RAYAS (reversible rayas/liso)

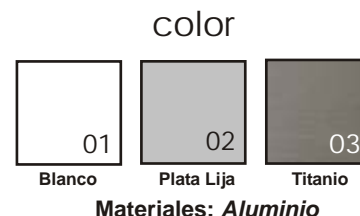

Componentes: riel + soportes + terminales + correderas + trabador

Correderas: - Riel **standard** corredera **77001**

- Riel **onda perfecta** corredera **77002** (60 mm)

Instalación TECHO (Soporte 1217004)

MEDIDAS EN €/cm

Corredera	Ref:	100	150	175	200	225	250	300	350	400
Standard RAYAS	12181103	85	94	103	106	112	120	139	147	156
Standard VENTANAS	12181102									
Onda perf. RAYAS	12182103	90	102	111	116	123	132	153	164	174
Onda perf. VENTANAS	12182102									
Soportes		2	2	2	3	3	3	4	4	5

Instalación PARED (Standard soporte 1217006 / Onda perfecta soporte 1217007)

MEDIDAS EN €/cm

Corredera	Ref:	100	150	175	200	225	250	300	350	400
Standard RAYAS	12181203	109	117	122	142	147	155	186	194	203
Standard VENTANAS	12181202									
Onda perf. RAYAS	12182203	115	126	131	152	159	168	201	212	223
Onda perf. VENTANAS	12182202									
Soportes		2	2	2	3	3	3	4	4	5

Para otros soportes ver sección accesorios.

Cierre centro



Izquierda



Derecha



Es **IMPORTANTE** indicar recogido de la cortina (Onda Perfecta).



Riel Decorativo 14x40 mm

color

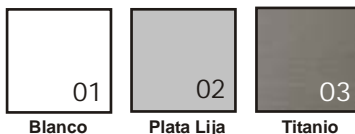

Blanco

Plata Lija

Titanio

Materiales: *Aluminio*

TERMINALES



Ventanas

Ref.		€ud
1217002	01 Blanco 02 Plata Lija 03 Titanio	23.00



Rayas/Liso

Ref.		€ud
1217003	01 Blanco 02 Plata Lija 03 Titanio	23.00

REVERSIBLE (liso/rayas)



Tapón

Ref.		€ud
1217001	01 Blanco 02 Plata Lija 03 Titanio	5.12

Riel Decorativo 14x40 mm



ACCESORIOS

Perfil riel 14x40 Aluminio



Ref.		€/ud	 (60)
1217000	01 Blanco		
	02 Plata lija	18.34	15.95
	03 Titanio		

Soporte Techo

Metal
Galvanizado

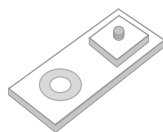

Ref.		€/ud	 (100)
1217004	01 Blanco		
	02 Plata lija	2.75	2.39
	03 Titanio		

Trabador

Metal
Plástico



Ref.		€/ud	 (100)
77000		0.55	0.48

Corredera



Ref.		€/ud	 (1000)
77001		0.075	0.066

Corredera Onda perfecta

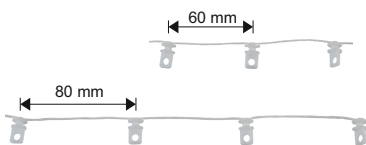

Ref.		€/ud	 (1000)
77002	60 mm	0.44	0.38
77003	80 mm	0.44	0.38

Cinta Onda perfecta

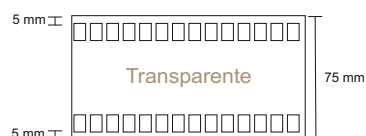

Ref.		€/ud	 (150)
77004	75 mm	1.50	1.30



Riel Decorativo 14x40 mm

ACCESORIOS

Garfio



Ref.		€/ud	 (1000)
77005	Metálico	0.018	0.016
77006	Plástico	0.028	0.024

Empalme Riel

Aluminio



Ref.		€/ud	 (20)
1217014		2.30	2.00

Tirador Plastificado Blanco 1 m



Ref.		€/ud	 (25)
77007		4.50	3.95

Enrolla hilos

Plástico

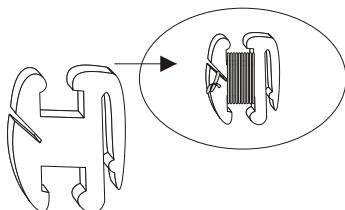

Ref.		€/ud	 (200)
77008		0.096	0.084

Riel Decorativo 14x40 mm



color

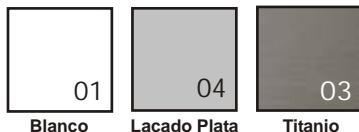

Blanco Lacado Plata Titanio

Materiales: *Aluminio*

SOPORTE VALENCIA



Soporte TECHO VALENCIA

Soporte techo

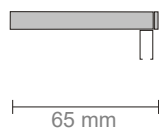

Ref.	Color	€ud
1217005	01 Blanco	8.00
	04 Lacado Plata	
	03 Titanio	

Soporte PARED VALENCIA



Soporte Pared 80 mm

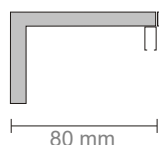

Ref.	Color	€ud
1217006	01 Blanco	18.29
	04 Lacado Plata	
	03 Titanio	

Soporte Pared 120 mm

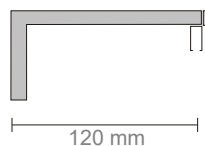

Ref.	Color	€ud
1217007	01 Blanco	18.80
	04 Lacado Plata	
	03 Titanio	

Soporte Pared 160 mm

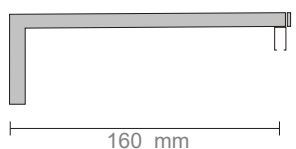

Ref.	Color	€ud
1217008	01 Blanco	21.34
	04 Lacado Plata	
	03 Titanio	

Soporte Pared 200 mm

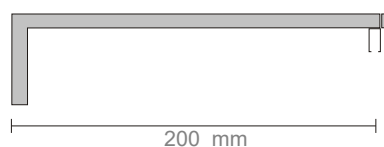

Ref.	Color	€ud
1217009	01 Blanco	22.86
	04 Lacado Plata	
	03 Titanio	



Riel Decorativo 14x40 mm

color

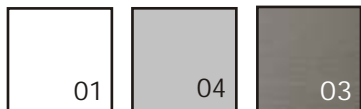

Blanco Lacado Plata Titanio

Materiales: *Aluminio*

SOPORTE VALENCIA

Soporte DOBLE TECHO VALENCIA



Soporte DOBLE techo

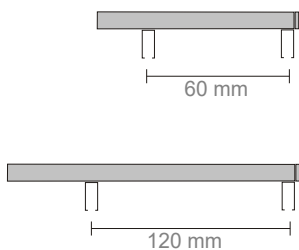

Ref.	Color	€/ud
1217010	01 Blanco	8.07
	04 Lacado Plata	
	03 Titanio	
1217011	01 Blanco	10.64
	04 Lacado Plata	
	03 Titanio	

Soporte DOBLE PARED VALENCIA



Soporte DOBLE Pared 160 mm

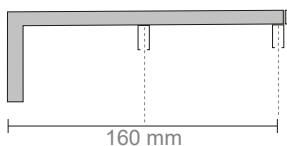

Ref.	Color	€/ud
1217012	01 Blanco	22.06
	04 Lacado Plata	
	03 Titanio	

Soporte DOBLE Pared 200 mm

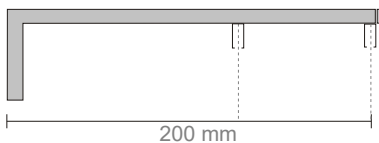

Ref.	Color	€/ud
1217013	01 Blanco	23.58
	04 Lacado Plata	
	03 Titanio	

Estos soportes permiten elegir la distancia entre rieles 60 o 80 mm.

Riel decorativo 14x40 mm



CONFECCIÓN ONDA PERFECTA

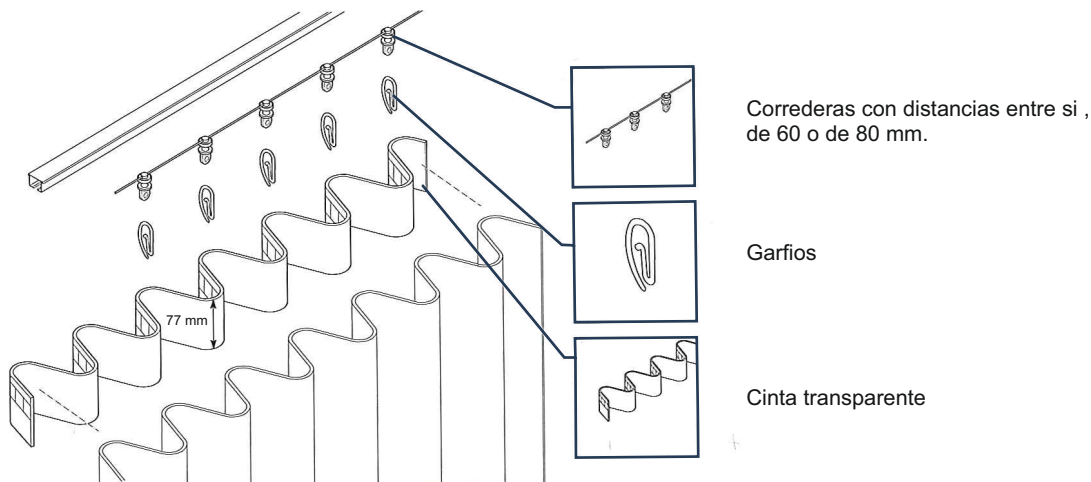

CÁLCULO DE TEJIDO, CINTA Y CORREDERAS NECESARIAS

A Longitud del riel o anchura de la cortina.

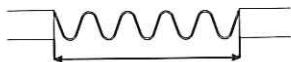

B Aconsejamos utilice un número par de correderas.

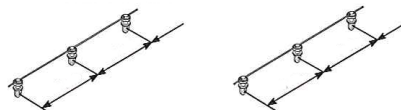

C Anchura paquete de cortina cerrada.

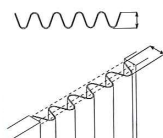

D Anchura paquete de cortina abierta.

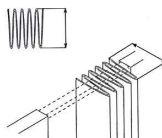

E Número de presillas entre garfios.

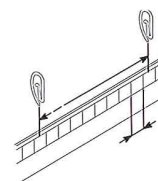

Corredera 60 mm

A	100	120	140	160	180	200	220	240	260	280	300	320	340	360	380	400	C	D
B	18	22	24	28	32	34	38	42	44	48	52	54	58	62	64	68		
E	TELA Y CINTA NECESARIA EN cm																cm	cm
12	216	240	288	336	360	408	456	480	528	576	600	648	696	720	768	816	9.28	12
13	234	260	312	364	390	442	494	520	572	624	650	702	754	780	832	884	10.55	13
14	252	280	336	392	420	476	532	560	616	672	700	756	812	840	896	952	11.83	14
15	270	300	360	420	450	510	570	600	660	720	750	810	870	900	960	1020	13.10	15
16	288	320	384	448	480	544	608	640	704	768	800	864	928	960	1024	1088	14.37	16

Corredera 80 mm

A	100	120	140	160	180	200	220	240	260	280	300	320	340	360	380	400	C	D
B	14	16	20	22	24	26	30	32	34	36	40	42	44	46	50	52		
E	TELA Y CINTA NECESARIA EN cm																cm	cm
12	168	192	216	240	288	312	336	360	408	432	456	480	528	552	576	600	7.28	12
13	182	208	234	260	312	338	364	390	442	468	494	520	572	598	624	650	8.55	13
14	196	224	252	280	336	364	392	420	476	504	532	560	616	644	672	700	9.83	14
15	210	240	270	300	360	390	420	450	510	540	570	600	660	690	720	750	11.10	15
16	224	256	288	320	348	416	448	480	544	576	608	640	704	736	768	800	12.37	16





RIEL DECORATIVO

23 x 21





Riel decorativo 23x21 mm

SISTEMA MONTADO A MEDIDA

ACC. MANUAL

MOD. TAPÓN



color



Blanco Plata Lija

Materiales: **Aluminio**

Componentes: riel + soportes + terminales + correderas +trabador

Correderas: - Riel **standard** corredera **77001**

- Riel **onda perfecta** corredera **77002** (60 mm)

Instalación **TECHO** (Soporte **1227001**)

MEDIDAS EN €/cm

Corredera	Ref:	100	150	175	200	225	250	300	350	400
Standard	12281101	41	50	56	60	66	72	85	94	103
Onda perf.	12282101	47	56	64	68	75	83	98	109	119
Soportes		2	2	2	3	3	3	4	4	5

Instalación **PARED** (Standard soporte **1227006** / Onda perfecta soporte **1227007**)

MEDIDAS EN €/cm

Corredera	Ref:	100	150	175	200	225	250	300	350	400
Standard	12281201	68	76	96	99	106	112	138	147	156
Onda perf.	12282201	75	83	105	109	116	124	152	163	175
Soportes		2	2	2	3	3	3	4	4	5

Para otros soportes ver sección accesorios.

Cierre centro



Izquierda



Derecha



Es **IMPORTANTE** indicar recogida de la cortina (Onda Perfecta).

Riel Decorativo 23x21 mm



SISTEMA MONTADO A MEDIDA

ACC. CORDÓN



color



Blanco Plata Lija
Materiales: **Aluminio**

Componentes: riel + soportes + terminales + correderas + trabador+cordón+conj. poleas +cruzador o arrastrador+contrapeso

Correderas: - Riel **standard** corredera **77001**

- Riel **onda perfecta** corredera **77002** (60 mm)

Instalación TECHO (Soporte 1227001)

MEDIDAS EN €/cm

Corredera	Ref:	100	150	175	200	225	250	300	350	400
Standard	12281102	70	79	85	89	95	107	123	132	141
Onda perf.	12282102	77	86	94	98	105	118	136	147	158
Soportes		2	2	2	3	3	3	4	4	5

Instalación PARED (Standard soporte 1227006 / Onda perfecta soporte 1227007)

MEDIDAS EN €/cm

Corredera	Ref:	100	150	175	200	225	250	300	350	400
Standard	12281202	97	106	126	129	136	147	176	186	195
Onda perf.	12282202	104	113	135	139	146	159	190	201	213
Soportes		2	2	2	3	3	3	4	4	5

Para otros soportes ver sección accesorios.

Cierre centro



Izquierda



Derecha



Es **IMPORTANTE** indicar recogido de la cortina (Onda Perfecta).



Riel Decorativo 23x21mm

color



Blanco Plata Lija
Materiales: **Aluminio**

TERMINALES



Tapón Aluminio

Ref.		€ud
1227016	01 Blanco	7.50
	02 Plata lija	



Tapón para Riel Cordón



Tapón Plástico con Poleas

Ref.		€ud
1227015		10.40



Tapón Plástico con Poleas

Ref.		€ud
1227014	01 Blanco	6.40
	02 Plata lija	

Riel Decorativo 23x21mm



ACCESORIOS

color

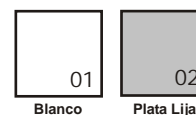

Perfil riel

Aluminio
23x21mm



Ref.		€ud	(60)
1227000	01 Blanco	19.49	16.95
	02 Plata lija		

Soporte Techo

Acero Galvanizado



Ref.		€ud	(100)
1227001		1.15	0.98

Trabador

Acero / nylon



Ref.		€ud	(100)
77000		0.55	0.48

Corredera



Ref.		€ud	(1000)
77001		0.075	0.066

Posibilidad de añadir o quitar correderas sin desmontar riel

Corredera Onda perfecta

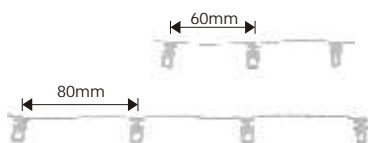

Ref.		€ud	(1000)
77002	60 mm	0.44	0.38
77003	80 mm	0.44	0.38



ACCESORIOS

Garfio



Ref.		€ud	 (1000)
77005	Metálico	0.018	0.016
77006	Plástico	0.028	0.024

Arrastrador



Ref.	€ud	 (100)
1227002	2.00	1.70

Cinta Onda perfecta

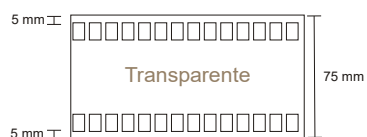

Ref.		€ud	 (150)
77004	75 mm	1.50	1.30

Cordón

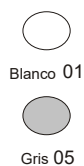

Ref.	Color	Medida	€ud	 (300)
1227003	01 Blanco	3.5 mm	0.32	0.28
	05 Gris			



Riel Decorativo 23x21mm

ACCESORIOS

Contrapeso 105 gr

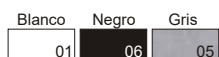

Ref.		€ud	 (50)
1227004	01 Blanco.		
	06 Negro	3.68	3.20
	05 Gris		

Tirador Plastificado Blanco 1 m



Ref.		€ud	 (25)
77007		4.50	3.95

Enrolla hilos

Plástico

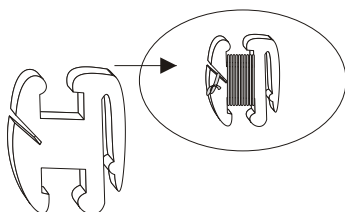

Ref.		€ud	 (200)
77008		0.096	0.084



Riel Decorativo 23x21mm

color

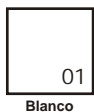

01
Blanco



04
Lacado Plata

SOPORTES VALENCIA

Soporte TECHO VALENCIA



Soporte techo

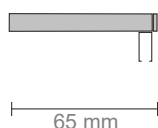

Ref.	Color	€ud
1227005	01 Blanco	8.00
	04 Lacado Plata	

Soporte PARED VALENCIA



Soporte Pared 80 mm

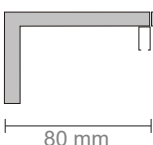

Ref.	Color	€ud
1227006	01 Blanco	18.29
	04 Lacado Plata	

Soporte Pared 120 mm

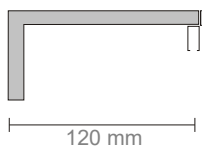

1227006	01 Blanco	18.80
	04 Lacado Plata	

Soporte Pared 160 mm

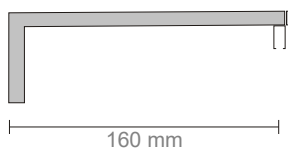

1227006	01 Blanco	21.34
	04 Lacado Plata	

Soporte Pared 200 mm

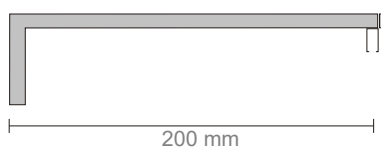

1227006	01 Blanco	22.86
	04 Lacado Plata	

Riel Decorativo 23x21mm



color

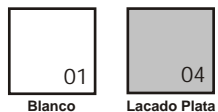

SOPORTES VALENCIA

Soporte DOBLE TECHO VALENCIA



Soporte DOBLE techo

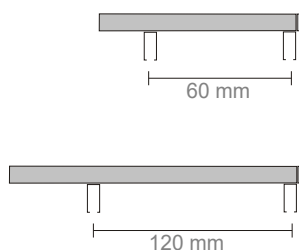

Ref.	Color	€ud
1227012	01 Blanco 04 Lacado Plata	8.07
1227012	01 Blanco 04 Lacado Plata	10.64

Soporte DOBLE PARED VALENCIA



Soporte DOBLE Pared 160 mm

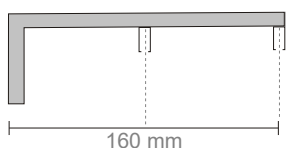

Ref.	Color	€ud
1227012	01 Blanco 04 Lacado Plata	22.06

Soporte DOBLE Pared 200 mm

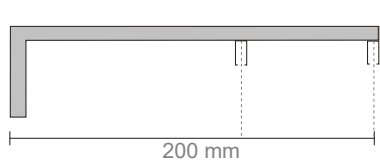

Ref.	Color	€ud
1227013	01 Blanco 04 Lacado Plata	23.58

Estos soportes permiten elegir la distancia entre rieles 60 o 80 mm.

Riel decorativo 23x21 mm



CONFECCIÓN ONDA PERFECTA

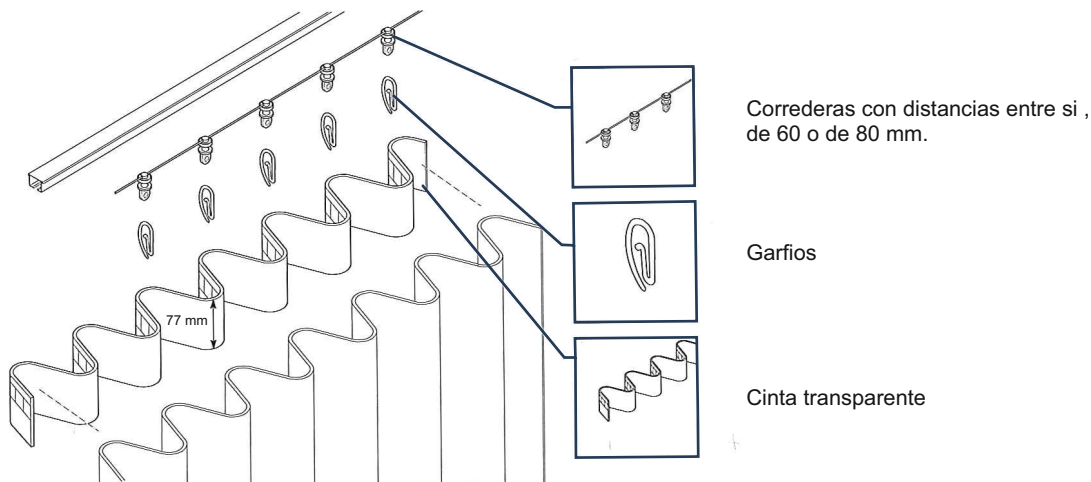

CÁLCULO DE TEJIDO, CINTA Y CORREDERAS NECESARIAS

A Longitud del riel o anchura de la cortina.

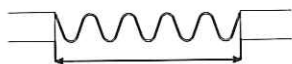

B Aconsejamos utilice un número par de correderas.

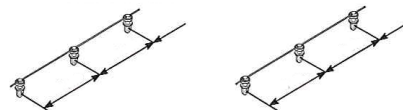

C Anchura paquete de cortina cerrada.

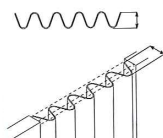

D Anchura paquete de cortina abierta.

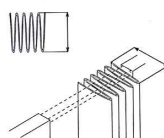

E Número de presillas entre garfios.

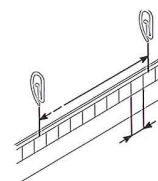

Corredera 60 mm

A	100	120	140	160	180	200	220	240	260	280	300	320	340	360	380	400	C	D
B	18	22	24	28	32	34	38	42	44	48	52	54	58	62	64	68		
E	TELA Y CINTA NECESARIA EN cm																cm	cm
12	216	240	288	336	360	408	456	480	528	576	600	648	696	720	768	816	9.28	12
13	234	260	312	364	390	442	494	520	572	624	650	702	754	780	832	884	10.55	13
14	252	280	336	392	420	476	532	560	616	672	700	756	812	840	896	952	11.83	14
15	270	300	360	420	450	510	570	600	660	720	750	810	870	900	960	1020	13.10	15
16	288	320	384	448	480	544	608	640	704	768	800	864	928	960	1024	1088	14.37	16

Corredera 80 mm

A	100	120	140	160	180	200	220	240	260	280	300	320	340	360	380	400	C	D
B	14	16	20	22	24	26	30	32	34	36	40	42	44	46	50	52		
E	TELA Y CINTA NECESARIA EN cm																cm	cm
12	168	192	216	240	288	312	336	360	408	432	456	480	528	552	576	600	7.28	12
13	182	208	234	260	312	338	364	390	442	468	494	520	572	598	624	650	8.55	13
14	196	224	252	280	336	364	392	420	476	504	532	560	616	644	672	700	9.83	14
15	210	240	270	300	360	390	420	450	510	540	570	600	660	690	720	750	11.10	15
16	224	256	288	320	348	416	448	480	544	576	608	640	704	736	768	800	12.37	16



RIEL DECORATIVO 23 X 27





Riel Decorativo 23X27

SISTEMA MONTADO A MEDIDA

ACC. MANUAL

MOD. TAPÓN



Plano



Recto

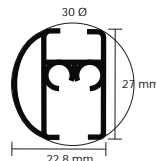

color



Blanco



Plata lija



Negro

Materiales: **Aluminio**

Componentes: riel + soportes + terminales + correderas + trabador

Correderas: - Riel **standard** corredera **77009**

- Riel **onda perfecta** corredera **77004** (60 mm)

Instalación TECHO

(Soporte **1217004**)

MEDIDAS EN €/cm

Corredera	Ref:	100	150	175	200	225	250	300	350	400	
Standard	Cuadrado	12381114	55	65	71	82	89	94	109	125	139
	Redondo	12381115									
Onda perf.	Cuadrado	12382114	57	69	75	86	93	99	115	132	147
	Redondo	12382115									
Soportes		2	2	2	3	3	3	3	4	4	

Instalación PARED

(Standard soporte **1217006** / Onda perfecta soporte **1217007**)

MEDIDAS EN €/cm

Corredera	Ref:	100	150	175	200	225	250	300	350	400	
Standard	Cuadrado	12381124	75	85	91	112	118	123	133	164	172
	Redondo	12381125									
Onda perf.	Cuadrado	12382124	78	89	95	117	124	130	140	173	182
	Redondo	12382125									
Soportes		2	2	2	3	3	3	3	4	4	

Para otros soportes ver sección accesorios.

Cierre centro



Izquierda



Derecha



Es **IMPORTANTE** indicar recogido de la cortina (Onda perfecta).

Riel Decorativo 23X27



SISTEMA MONTADO A MEDIDA

ACC. CORDÓN

MOD. TAPÓN

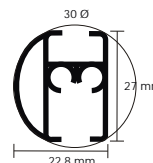

color



Blanco Plata lija Negro
Materiales: **Aluminio**

Componentes: riel + soportes + terminales + correderas + trabador + cordón + conj. Poleas + cruzador o arrastrador + contrapeso.

Correderas: - Riel **standard** corredera **77009**

- Riel **onda perfecta** corredera **77004** (60 mm)

Instalación TECHO

(Soporte 1217004)

MEDIDAS EN €/cm

Corredera	Ref:	100	150	175	200	225	250	300	350	400	
Standard	Cuadrado	12381214	82	93	99	112	118	124	141	158	173
	Redondo	12381215									
Onda perf.	Cuadrado	12382214	85	96	103	116	123	130	147	165	181
	Redondo	12382215									
Soportes		2	2	2	3	3	3	3	4	4	

Instalación PARED

(Standard soporte 1217006 / Onda perfecta soporte 1217007)

MEDIDAS EN €/cm

Corredera	Ref:	100	150	175	200	225	250	300	350	400	
Standard	Cuadrado	12381224	101	112	118	140	147	153	164	197	206
	Redondo	12381225									
Onda perf.	Cuadrado	12382224	105	117	123	147	154	161	172	207	216
	Redondo	12382225									
Soportes		2	2	2	3	3	3	3	4	4	

Para otros soportes ver sección accesorios.

Cierre centro



Izquierda



Derecha



Es **IMPORTANTE** indicar recogido de la cortina (Onda perfecta).



Riel Decorativo 23X27

ACCESORIOS

color

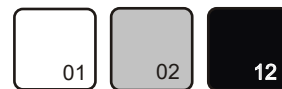

Blanco Plata lija Negro

Perfil riel

Aluminio
23x27mm

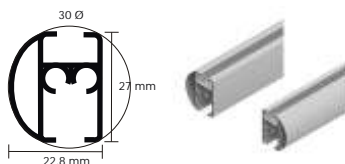

Ref.		€ud	(58)
1237000	01 Blanco	22.08	19.20
	02 Plata lija		
	12 Negro		

Soporte Techo

Aleación



Ref.		€ud	(100)
1217004	01 Blanco	4.60	4.00
	02 Gris		
	12 Negro		

Trabador

Acero / nylon



Ref.		€ud	(100)
77000		0.55	0.48

Correderas Ruedas

Plástico
Nylon

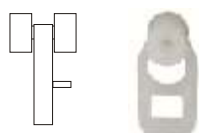

Ref.		€ud	(1000)
77009	01 Blanco	0.10	0.09
	02 Gris		
	12 Negro		

Corredera Onda perfecta

Poliamida

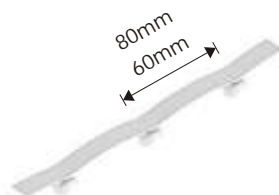

Ref.		€ud	(1000)
77004	60 mm	0.0966	0.0840
	01 Blanco		
	02 Gris		
77005	80 mm	0.0966	0.0840
	01 Blanco		
	02 Gris		

Riel Decorativo 23X27



color

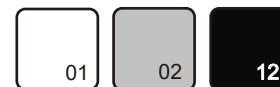

Blanco Plata lija Negro

Materiales: Aluminio

ACCESORIOS

Empalme Riel

Aluminio



Ref.	€ud	(20)
1217014	2.30	2.00

Conj.Poleas Cuadrado

Acero / nylon



Ref.	€ud	(6)
1237000	01 Blanco	21.51 18.70
	02 Gris	
	12 Negro	

Conj.Poleas Redondo

Acero / nylon



Ref.	€ud	(6)
1237001	01 Blanco	21.51 18.70
	02 Gris	
	12 Negro	

Conj. Tapón Cuadrado

Nylon



Ref.	€ud	(10)
1237002	01 Blanco	10.93 9.50
	02 Gris	
	12 Negro	

Conj. Tapón Redondo

Nylon



Ref.	€ud	(10)
1237003	01 Blanco	10.93 9.50
	02 Gris	
	12 Negro	



Riel Decorativo 23X27

ACCESORIOS

Cruzador

Nylon



Ref.		€ud	 (50)
1237004	01 Blanco	1.38	1.20
	02 Gris		
	12 Negro		

Lanzadera Onda Perfecta

Nylon



Ref.		€ud	 (50)
1237005	01 Blanco	1.55	1.35
	02 Gris		
	12 Negro		

Arrastrador

Nylon



Ref.		€ud	 (100)
1237006		0.45	0.39

Firme

Nylon



Ref.		€ud	 (50)
1237007	Transparente	0.11	0.10

Soporte Lateral Pared

Acero



Ref.		€ud	 (20)
1237008		2.59	2.25



ACCESORIOS

Contrapeso 105 gr



Ref.		€ud	(50)
1227004	01 Blanco.	3.68	3.20
	06 Negro		
	05 Gris		

Tirador Plastificado Blanco 1 m



Ref.		€ud	(25)
77007		4.50	3.95

Cinta Onda perfecta

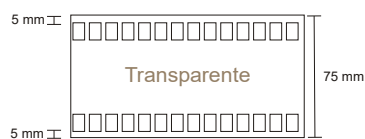

Ref.		€ud	(150)
77004	75 mm	1.50	1.30

Cordón



Ref.	Color	Medida	€ud	(200)
1227003	01 Blanco.	3.5 mm	0.59	0.51
	06 Negro			
	05 Gris			

Garfio



Ref.		€ud	(1000)
77005	Metálico	0.018	0.016
77006	Plástico	0.028	0.024

Enrolla hilos

Plástico

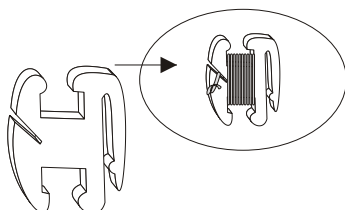

Ref.		€ud	(200)
77008		0.096	0.084



Riel Decorativo 23X27

color

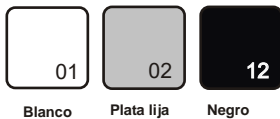

SOPORTES VALENCIA

Soporte TECHO VALENCIA



Soporte techo

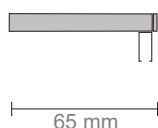

Ref.	Color	€ud
1217005	01 Blanco	8.00
	04 Lacado Plata	
	12 Negro	

Soporte PARED VALENCIA



Soporte Pared
80 mm

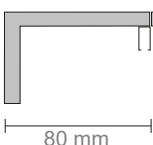

Ref.	Color	€ud
1217006	01 Blanco	18.29
	04 Lacado Plata	
	12 Negro	

Soporte Pared
120 mm

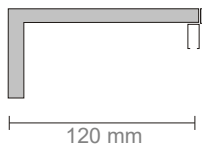

Ref.	Color	€ud
1217007	01 Blanco	18.80
	04 Lacado Plata	
	12 Negro	

Soporte Pared
160 mm

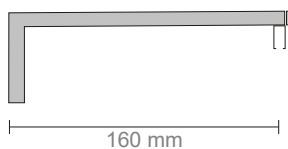

Ref.	Color	€ud
1217008	01 Blanco	21.34
	04 Lacado Plata	
	12 Negro	

Soporte Pared
200 mm

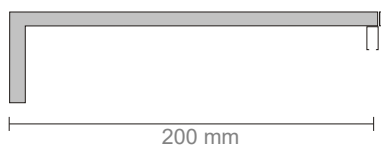

Ref.	Color	€ud
1217009	01 Blanco	22.86
	04 Lacado Plata	
	12 Negro	



color

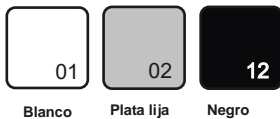

SOPORTES VALENCIA

Soporte DOBLE TECHO VALENCIA



Soporte DOBLE techo

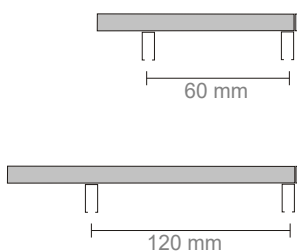

Ref.	Color	€ud
1217010	01 Blanco	8.07
	04 Lacado Plata	
	12 Negro	
1217011	01 Blanco	10.64
	04 Lacado Plata	
	12 Negro	

Soporte DOBLE PARED VALENCIA



Soporte DOBLE Pared 160 mm

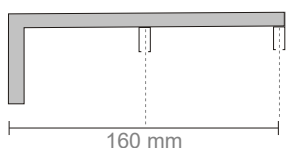

Ref.	Color	€ud
1217012	01 Blanco	22.06
	04 Lacado Plata	
	12 Negro	

Soporte DOBLE Pared 200 mm

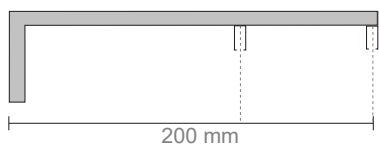

Ref.	Color	€ud
1217013	01 Blanco	23.58
	04 Lacado Plata	
	12 Negro	

Estos soportes permiten elegir la distancia entre rieles 60 o 80 mm.



Riel Decorativo 23X27

CONFECCIÓN ONDA PERFECTA

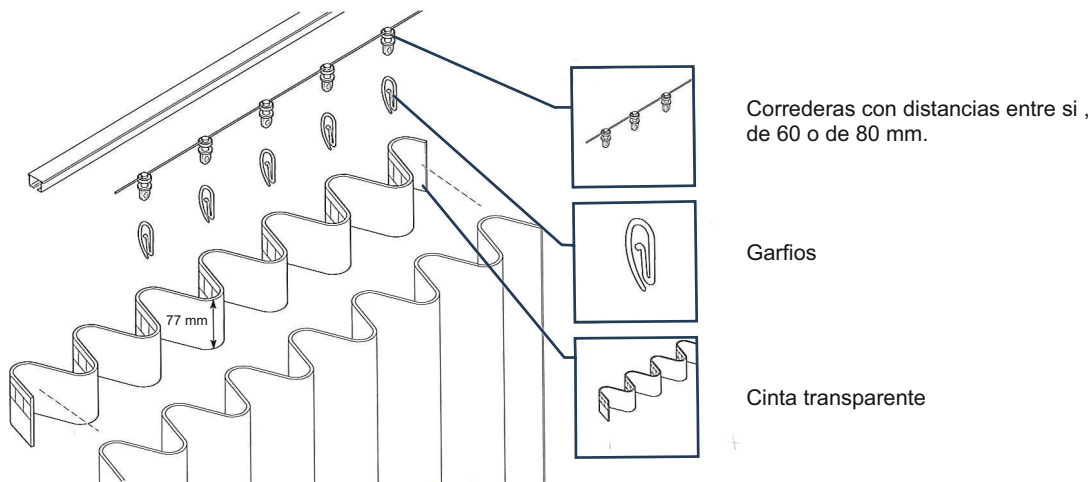

CÁLCULO DE TEJIDO, CINTA Y CORREDERAS NECESARIAS

A Longitud del riel o anchura de la cortina.

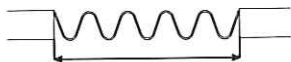

B Aconsejamos utilice un número par de correderas.

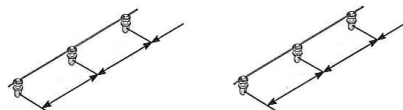

C Anchura paquete de cortina cerrada.

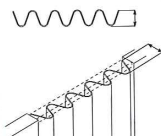

D Anchura paquete de cortina abierta.

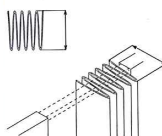

E Número de presillas entre garfios.

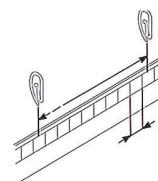

Corredera 60 mm

A	100	120	140	160	180	200	220	240	260	280	300	320	340	360	380	400	C	D
B	18	22	24	28	32	34	38	42	44	48	52	54	58	62	64	68		
E	TELA Y CINTA NECESARIA EN cm																cm	cm
12	216	240	288	336	360	408	456	480	528	576	600	648	696	720	768	816	9.28	12
13	234	260	312	364	390	442	494	520	572	624	650	702	754	780	832	884	10.55	13
14	252	280	336	392	420	476	532	560	616	672	700	756	812	840	896	952	11.83	14
15	270	300	360	420	450	510	570	600	660	720	750	810	870	900	960	1020	13.10	15
16	288	320	384	448	480	544	608	640	704	768	800	864	928	960	1024	1088	14.37	16

Corredera 80 mm

A	100	120	140	160	180	200	220	240	260	280	300	320	340	360	380	400	C	D
B	14	16	20	22	24	26	30	32	34	36	40	42	44	46	50	52		
E	TELA Y CINTA NECESARIA EN cm																cm	cm
12	168	192	216	240	288	312	336	360	408	432	456	480	528	552	576	600	7.28	12
13	182	208	234	260	312	338	364	390	442	468	494	520	572	598	624	650	8.55	13
14	196	224	252	280	336	364	392	420	476	504	532	560	616	644	672	700	9.83	14
15	210	240	270	300	360	390	420	450	510	540	570	600	660	690	720	750	11.10	15
16	224	256	288	320	348	416	448	480	544	576	608	640	704	736	768	800	12.37	16



Riel 1000-4000
2000-7000-9000





Riel 1000-4000 (Lacado Blanco)

SISTEMA MONTADO A MEDIDA

ACC. MANUAL



Componentes:
 Riel aluminio Lacado Blanco.
 Terminal tapón.
 Correderas **77009** con ruedas.
 Soporte plástico.



MEDIDAS EN €/cm

REF.	100	150	175	200	225	250	300	350	400	600	
1118100	9.96	12.74	16.76	18.01	19.95	20.79	23.76	27.50	29.80	Consultar	1
1118100	8.66	11.08	14.57	15.66	17.35	18.08	20.66	23.69	25.91	Consultar	10
Soportes	2	2	3	3	4	4	5	5	6	6	

ACCIONAMIENTO MANUAL ONDA PERFECTA (CORREDERA REF. 77002)

1118200	13.17	17.33	21.30	23.38	25.88	28.18	31.92	36.79	40.54	Consultar
----------------	--------------	--------------	--------------	--------------	--------------	--------------	--------------	--------------	--------------	------------------

ACC. MANUAL



Componentes:
 Riel aluminio Lacado Blanco.
 Terminal tapón.
 Correderas **77009** con ruedas.



MEDIDAS EN €/cm

REF.	100	150	175	200	225	250	300	350	400	600	
1148100	9.96	12.88	17.09	18.06	20.19	21.16	24.04	27.91	30.30	Consultar	1
1148100	8.66	11.20	14.86	15.70	17.56	18.04	20.90	24.27	26.35	Consultar	10
Soportes	2	2	3	3	4	4	5	5	6	6	

ACCIONAMIENTO MANUAL ONDA PERFECTA (CORREDERA REF. 77002)

1148200	12.98	17.47	21.63	23.43	26.12	28.54	32.20	37.46	41.04	Consultar
----------------	--------------	--------------	--------------	--------------	--------------	--------------	--------------	--------------	--------------	------------------



Es **IMPORTANTE** indicar recogido de la cortina (Onda perfecta).

Riel 1000/4000 (Lacado Blanco)



ACCESORIOS

Perfil riel 1000 Aluminio (lacado blanco)

X = 15 mm
Y = 18 mm

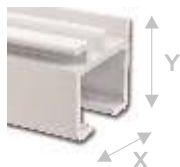

Ref.	€ud	 (60)
1117000	5.29	4.60

Perfil riel 4001 Aluminio (lacado blanco)

X = 27 mm
X₂ = 13 mm
Y = 11 mm

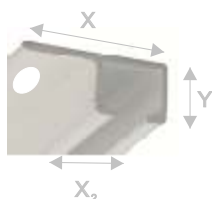

Ref.	€ud	 (60)
1147000	5.52	4.80

Soporte riel 1001



Plástico



Metálico

Ref.		€ud	 (200)
1117001	Plástico	0.36	0.28
1117002	Metálico	0.74	0.69

Terminal tapón

Plástico
Blanco



Ref.	€ud	 (200)
1107000	0.40	0.34

Correderas Ruedas

Plástico
Blanco

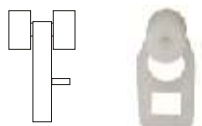

Ref.	€ud	 (1000)
77009	0.10	0.09

Corredera Onda perfecta

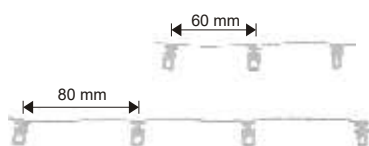

Ref.		€ud	 (1000)
77002	60 mm	0.44	0.38
77003	80 mm	0.44	0.38



Riel 1000-4000 (Lacado Blanco)

ACCESORIOS

Trabador

Metal
Plástico



Ref.	€ud	 (100)
77000	0.55	0.48

Garfios



Plástico

Metálico

Ref.	€ud	 (1000)
77005	0.018	0.016
77006	0.028	0.024

Contrapeso blanco 90gr.

Plástico
Blanco
Acero



Ref.	€ud	 (50)
4107018	1.84	1.60

Tensor



Ref.	€ud	 (50)
77013	1.61	1.40

Enrolla hilos

Plástico

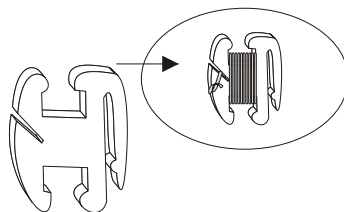

Ref.	€ud	 (100)
77008	0.96	0.84

Tirador Plastificado Blanco 1 m



Ref.	€ud	 (25)
77007	4.50	3.95

Riel 2000/6000/9000 (Lacado Blanco)



SISTEMA MONTADO A MEDIDA 2000



ACC. MANUAL

Componentes:

Riel aluminio Lacado Blanco.
Terminal tapón.
Correderas **77009** con ruedas.
Correderas Onda Perfecta **77002**.

MEDIDAS EN €/cm

REF.	100	150	175	200	225	250	300	350	400	600	
1128100	21	27	36	38	43	45	51	59	64	Consultar	1
1128100	18	24	31	33	37	39	45	51	56	Consultar	10
ACCIONAMIENTO MANUAL ONDA PERFECTA											
1128200	27	37	45	49	54	59	68	78	86	Consultar	1

SISTEMA MONTADO A MEDIDA 6000/9000



ACC. MANUAL

Componentes:

Riel aluminio Lacado Blanco.
Terminal tapón.
Correderas **77009** con ruedas.
Correderas Onda Perfecta **77002**.

MEDIDAS EN €/cm

REF.	100	150	175	200	225	250	300	350	400	600	
1168100	27	36	46	51	57	61	70	82	89	Consultar	1
1138100	31	42	54	59	67	71	83	97	107	Consultar	1



Riel 2000/6000/9000 (Lacado Blanco)

ACCESORIOS

Perfil riel doble vía Lacado Blanco

Aluminio
X = 73 mm
Y = 13 mm

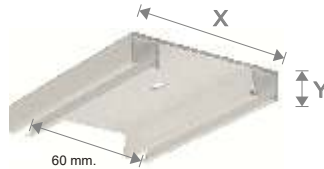

Ref.	€ud	 (60)
1127000	13.80	12.00

Perfil riel triple vía Lacado Blanco

Aluminio
X = 173 mm
Y = 13 mm

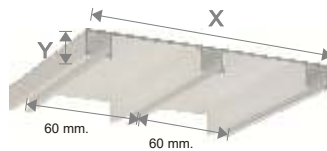

Ref.	€ud	 (60)
1137000	27.14	23.60

Perfil riel triple vía ASIMÉTRICO Lacado Blanco

Aluminio
X = 173 mm
Y = 13 mm

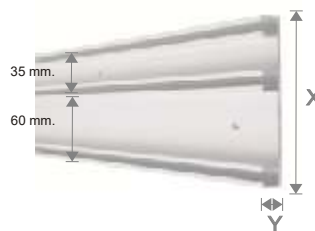

Ref.	€ud	 (60)
1167000	24.04	20.90

Terminal tapón

Plástico Blanco



Ref.	€ud	 (200)
1107000	0.40	0.34

Correderas



Ref.	€ud	 (1000)
77009	0.10	0.09

Corredera Onda perfecta

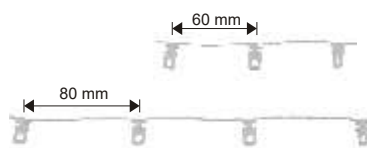

Ref.		€ud	 (1000)
77002	60 mm	0.44	0.38
77003	80 mm	0.44	0.38

ESCUADRAS



ESCUADRA PARED ALUMINIO



* TORNILLO LARGO M:4x10 mm
PARA INSTALACION CON
SOPORTES DE MAYOR GROSOR



Ref.	Medida	1	€/ud		€/ud		€/ud		€/ud	
			(25)	(25)	(25)	(25)	(25)	(25)		
6117000	5 cm	1	2.82	2.45	3.23	2.81	3.23	2.81	3.23	2.81
	8 cm	1	3.28	2.85	3.76	3.27	3.76	3.27	3.76	3.27
	12 cm	1	4.03	3.50	4.63	4.03	4.63	4.03	4.63	4.03
	16 cm	2	5.73	4.98	6.58	5.72	6.58	5.72	6.58	5.72
	20 cm	2	6.38	5.55	7.34	6.38	7.34	6.38	7.34	6.38
			Color 01 Blanco Brillo		Color 03 Titanio		Color 04 Lacado Plata		Color 12 Negro	

TUERCA CON TORNILLO ESCUADRA

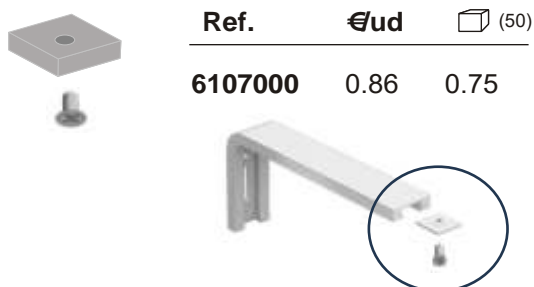

Ref.	€/ud	(50)
6107000	0.86	0.75

EXTENSION ESCUADRA DE ALUMINIO



Ref.	€/ud	(25)
6107001	2.21	1.92

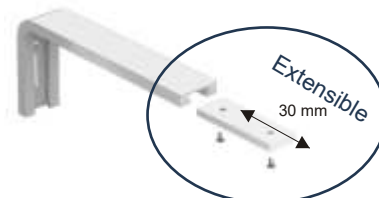

EMBELLECEDOR ESCUADRA DE ALUMINIO



Ref.	€/ud	(25)
6137000	01 Blanco	8.67 7.54
	03 Titanio	9.19 7.99
	04 Lacado Plata	9.19 7.99
	12 Negro	9.19 7.99

PROYECCIÓN VALENCIA

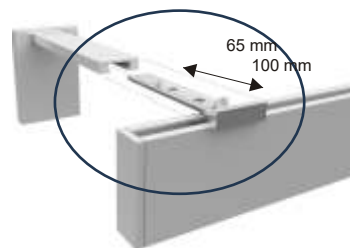

Ref.	€/ud	(25)
6107002	65 mm. 01 Blanco	5.74 4.99
	65 mm. 03 Titanio	
	65 mm. 04 Lacado Plata	
	65 mm. 12 Negro	
6107003	100 mm. 01 Blanco	8.04 6.99
	100 mm. 03 Titanio	
	100 mm. 04 Lacado Plata	
	100 mm. 12 Negro	

PVP IVA no incluido



ESCUADRAS

ESCUADRA PARED ROSCADA



Ref.	Medida	€ud	(50)
6207000	45 mm	1.92	1.67
	90 mm	2.54	2.21
	150 mm	3.49	2.91
	180 mm	4.06	3.38

SOPORTE INSTALACIÓN SIN AGUJEROS

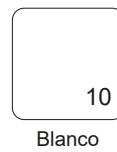

Blanco



Gris

Soporte Instalación Techo



AJUSTABLE
AL GROSOR
DEL VENTANAL

Ref.	€ud	(25)
6307001	7.50	6.52
	7.50	6.52



PARTE FRONTAL



PARTE TRASERA

Soporte Instalación Pared



AJUSTABLE
AL GROSOR
DEL VENTANAL

Ref.	€ud	(25)
6307001	7.50	6.52
	7.50	6.52



PARTE FRONTAL



PARTE TRASERA

Tuerca con tornillo Fijación riel soporte techo

Ref.	€ud	(25)
6307002	0.98	0.78



Tuerca con tornillo Fijación riel soporte pared

Ref.	€ud	(25)
6307003	0.08	0.07



PVP IVA no incluido



RIELES MOTORIZADOS



Motorización RIELES



AM-75 PLUS



El motor cortina vía radio silencioso M75 es una combinación perfecta de tecnología alemana. El diseño patentado es simple y exquisito con un gran rendimiento.

AM-75 PLUS WIREFREE



El motor cortina vía radio silencioso M75 WUREFREE brinda una solución sin cableado eléctrico a través de alimentación por batería externa.

Características

- El motor tiene tres tecnologías patentadas silenciosas.
 - Cada caja de cambios adopta la estructura de doble rodamiento.
 - Diseño oculto para colocar el soporte a techo.
 - Ruido de funcionamiento por debajo de 40 dB.
 - Confeccionable a medida.
 - 3 velocidades seleccionables.
 - Bi-Voltaje: Fuente de alimentación AC100-AC240V compatible a nivel mundial.
 - Conexión en tándem: Conexión de varios motores juntos a través de Rj12 para control de grupal.
 - Detección de obstáculos: El motor se detiene automáticamente para proteger el producto final en en cuanto encuentra una resistencia.
 - Función tacto ligero: Con el motor en modo ON, al estirar de la cortina aproximadamente 5 cm. , el motor se acciona abriendo o cerrando automáticamente.
 - Operación manual: Con el motor en modo OFF, el motor queda desbloqueado automáticamente para poder abrir y cerrar la cortina de forma manual.
 - Varios métodos de funcionamiento: Opción vía radio , pulsador , RS232/485 , línea BUS , etc...
- Aplicación inalámbrica sin costes de instalación elevados. AM-75 PLUS WIREFREE

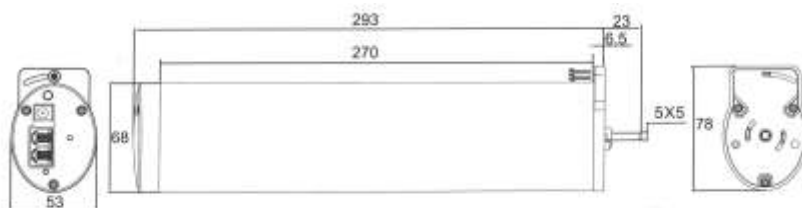

Motorización RIELES



Nombre	Modelo	Vel.	Tamaño	Voltaje	Potencia	IP	Funciones
	AM75-1.5/ 100 EQ-P	16 cm/s	316x68x53	AC100-240V 50/60 Hz	80W	Ip20	*Función memoria *Diseño super silencioso *Interruptor manual *Control grupal *Velocidad ajustable *Detección de obstáculos *Control varias opciones *Movimiento táctil

Formas de riel

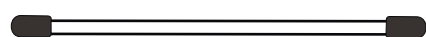

Riel recto



Riel curvo

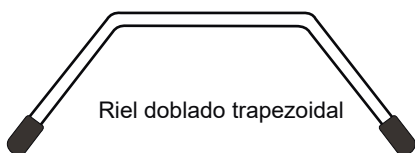

Riel doblado trapezoidal

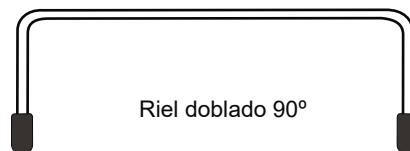

Riel doblado 90°

Combinaciones

De una sola vía, un solo motor con una sola polea



De una sola vía, un solo motor con doble polea

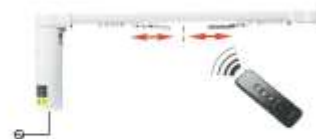

Doble vía, doble motor con una sola polea



Doble vía, doble motor con doble polea

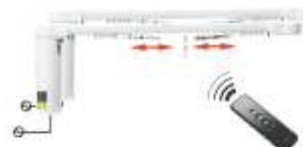

De una sola vía doble motor con doble polea





Motorización RIELES

CONSULTAR PVP



Blanco Brillo



Negro Brillo



Lacado Plata

Ref.13181
M-75 PLUS

Ref.13281
AM-75PLUS
WIREFREE

MEDIDA	SOPORTES	CORREDERAS	PVP VIA RADIO	PVP BATERIA
150	3	16	392	610
200	3	20	414	632
250	4	26	451	669
300	4	30	488	706
350	5	36	514	733
400	5	40	546	765
450	6	46	588	807
500	6	50	610	829
550	7	56	647	866
600*	7	60	669	888
700*	10	70	753	972
800*	12	80	805	1023
900*	14	90	861	1079
1000*	16	100	913	1131

PARA MEDIDAS SUPERIORES Y CURVADOS - CONSULTAR

CONJUNTOS COMPLETOS CON SOPORTE A TECHO Y MANDO INCLUIDO

OPCIONES E INCREMENTOS:

Motor extra. 242 €
 Sistema Onda perfecta/m 12 €
 Curva 90° 140 €

Cierre centro



Izquierda



Derecha



Es IMPORTANTE indicar recogido de la cortina.

PVP IVA no incluido



RIEL FLEXI





RIEL FLEXI

SISTEMA MONTADO A MEDIDA

ACC. MANUAL

RIEL FÁCIL DE CURVAR (MANUALMENTE)



color



Blanco

Opción para otros colores
Consultar

Materiales: *Aluminio*

Componentes:

Riel

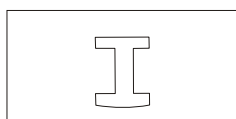

Correderas



Terminales



Soportes

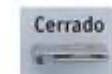

SISTEMA MONTADO RIEL DOBLE T

MEDIDAS EN €/cm

Ref:	Colores	Corredera	100	150	200	250	300	350	400
1158100	Blanco brillo	Nylon	14.56	17.34	27.21	29.99	32.96	36.45	39.00
		Soportes	2	3	4	4	6	7	8

Cualquier modificación de componentes (soportes, correderas) aumentará el precio base.
Consultar precio para **contract**.

RIEL FLEXI



color



Blanco

Opción para otros colores
Consultar

Materiales: Aluminio

ACCESORIOS

Perfil de Aluminio

Aluminio
18x5 mm

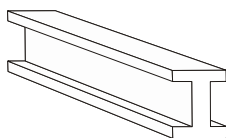

Ref.		€ud	 (60)
1157000	Blanco	3.97	3.45

Soporte techo Metálico

Acero

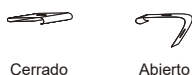
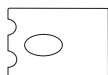

Cerrado Abierto

Ref.		€ud	 (100)
1157001	Blanco	1.21	1.06

Terminal tope

Acero

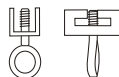

Ref.		€ud	 (100)
1157002	Acero	1.05	0.91

Corredera Metálica/nylon con ruedas

Acero/nylon
Blanco

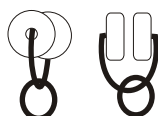

Ref.		€ud	 (500)
1157003	Blanco	0.56	0.48



ESCUADRAS

ESCUADRA PARED ALUMINIO



* TORNILLO LARGO M:4x10 mm
PARA INSTALACION CON
SOPORTES DE MAYOR GROSOR



Ref.	Medida	1	€/ud		€/ud		€/ud		€/ud	
			(25)	(25)	(25)	(25)	(25)	(25)		
6117000	5 cm	1	2.82	2.45	3.23	2.81	3.23	2.81	3.23	2.81
	8 cm	1	3.28	2.85	3.76	3.27	3.76	3.27	3.76	3.27
	12 cm	1	4.03	3.50	4.63	4.03	4.63	4.03	4.63	4.03
	16 cm	2	5.73	4.98	6.58	5.72	6.58	5.72	6.58	5.72
	20 cm	2	6.38	5.55	7.34	6.38	7.34	6.38	7.34	6.38
			Color 01 Blanco Brillo		Color 03 Titanio		Color 04 Lacado Plata		Color 12 Negro	

TUERCA CON TORNILLO ESCUADRA

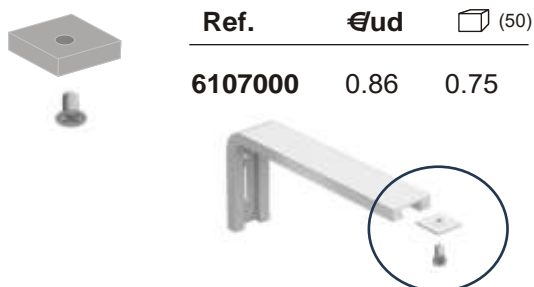

Ref.	€/ud	(50)
6107000	0.86	0.75

EXTENSION ESCUADRA DE ALUMINIO



Ref.	€/ud	(25)
6107001	2.21	1.92

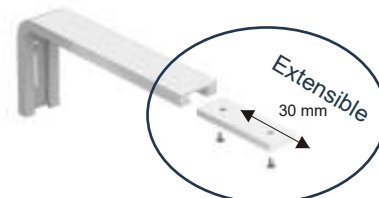

EMBELLECEDOR ESCUADRA DE ALUMINIO



Ref.	€/ud	(25)
6137000	01 Blanco	8.67 7.54
	03 Titanio	9.19 7.99
	04 Lacado Plata	9.19 7.99
	12 Negro	9.19 7.99

PROYECCION VALENCIA

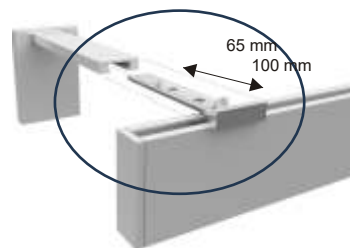

Ref.	€/ud	(25)
6107002	65 mm. 01 Blanco	
	65 mm. 03 Titanio	5.74 4.99
	65 mm. 04 Lacado Plata	
	65 mm. 12 Negro	
6107003	100 mm. 01 Blanco	
	100 mm. 03 Titanio	8.04 6.99
	100 mm. 04 Lacado Plata	
	100 mm. 12 Negro	

PVP IVA no incluido



GALERÍAS





Galería de Aluminio

CARTA DE COLORES



MADERA

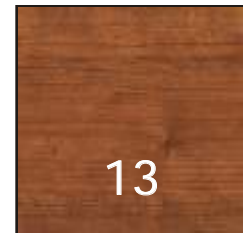

Cerezo

LACADOS

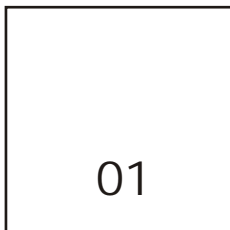

Blanco Brillo

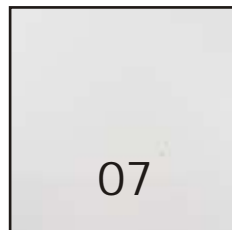

Natural

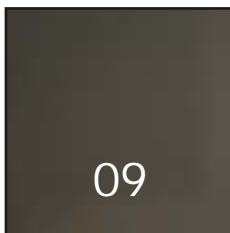

Gris Medio



Dorado

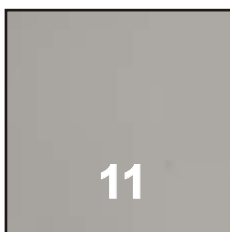

Visón

METALIZADOS

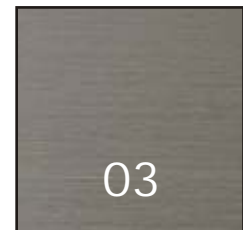

Titanio

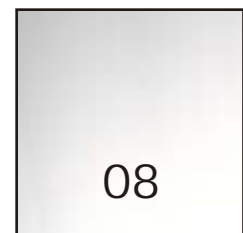

Brillo Grata

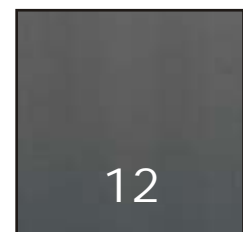

Negro Grata

Galería de Aluminio



LACADOS



METÁLICOS

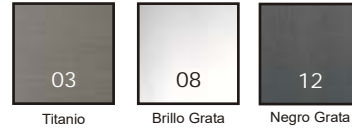

MADERAS

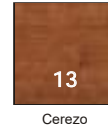

Galería Aluminio con Cantoneras



Vista frontal

Perfil



120 mm



PARA PEDIDOS: MEDIDAS INTERIORES

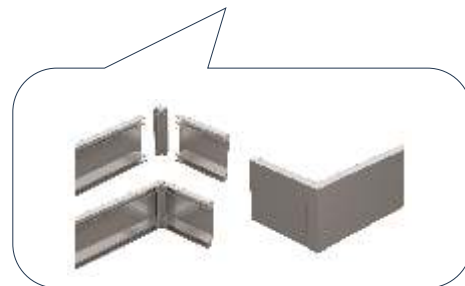
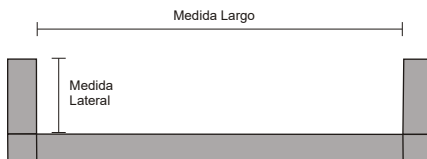

Conjunto Galería Aluminio con cantoneras

Las galerías incluyen 2 laterales de 15cm y llevarán empalme embellecedor a partir de 3.00 m

Medida en €/cm

Color	150	200	250	300	350	400
01	88.31	102.86	118.08	144.12	158.67	173.89
03 12	100.11	117.93	136.44	165.75	183.57	202.08
07 09 10 11	104.25	123.22	142.88	173.34	192.31	211.97
08 13	114.93	136.87	159.49	192.92	214.86	237.48

Simulación de precios para conjunto completo. El perfil se factura en cm

Las GALERÍAS se facturarán en despiece (perfil + cantoneras + soportes)



Galería de Aluminio

LACADOS



METÁLICOS

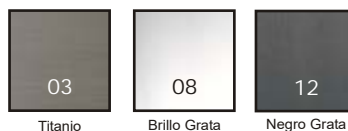

MADERAS

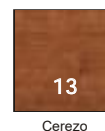

Galería Aluminio en Inglete

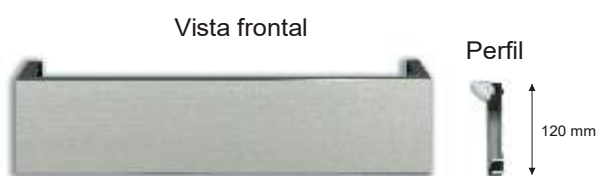

PARA PEDIDOS :MEDIDAS INTERIORES

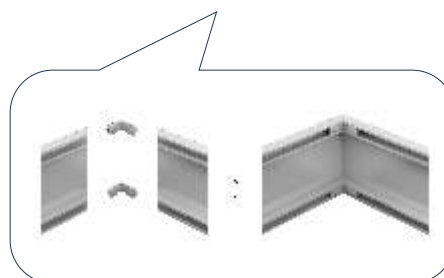
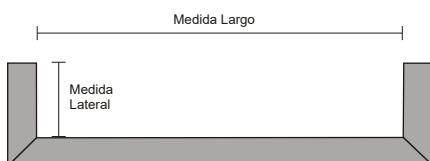

Conjunto Galería Aluminio en Inglete

Las galerías incluyen 2 laterales de 15cm y llevarán empalme embellecedor a partir de 3.00 m

Medida en €/cm

Color	150	200	250	300	350	400
01	72.80	89.53	106.93	135.15	151.88	169.29
03 12	86.37	106.86	128.04	160.03	180.53	201.70
07 09 10 11	91.13	112.95	135.45	168.76	190.58	213.08
08 13	114.93	136.87	159.49	192.92	214.86	237.48

Simulación de precios para conjunto completo. El perfil se factura en cm

Las GALERÍAS se facturarán en despiece (perfil inglete + escuadras inglete + soportes)

Galería de Aluminio



LACADOS



METÁLICOS

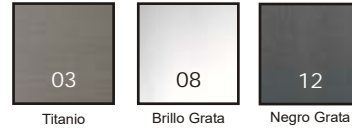

MADERAS

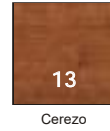

ACCESORIOS

Perfil Recto



Ref.	Color	€/m	 Metros (largo)
2117001	01	29.10	25.30 36 (6 m)
	03	35.65	31.00 36 (6 m)
	12		36 (6 m)
	07		18 (3 m)
	09	37.95	33.00 18 (3 m)
	10	18 (3 m)	
	11		18 (3 m)
	08		43.88
	13		

CORTE EN INGLETE EN METRAJE INCREMENTA 15 %

Cantonera



Ref.	Color	€/ud	 (20)
2007001	01	16.95	14.74
	07		
	09		
	11		
	03		
	12		
	10		
	08		
	13		



Empalme Embellecedor



Ref.	Color	€/ud	 (20)
2007002	01	10.81	9.40
	07		
	09		
	11		
	03		
	12		
	10		
	08		
	13		

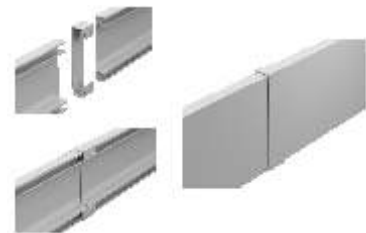

Empalme Articulado



Ref.	Color	€/ud	 (10)
2007003	01	43.64	37.95
	07		
	09		
	11		
	03		
	12		
	10		
	08		
	13		





Galería de Aluminio

LACADOS



01
Blanco Brillo

07
Natural

09
Gris Medio

10
Dorado

11
Visión

METÁLICOS



03
Titanio

08
Brillo Grata

12
Negro Grata

MADERAS

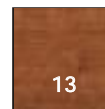

13
Cerezo

ACCESORIOS

Soporte Palanca



Ref.	€ud	 (200)
3207001	0.68	0.59



Escuadra Unión Perfil 90°



Ref.	€ud	 (50)
2007006	2.63	2.29



Escuadra Instalación Pared



Ref.	€ud	 (50)
2007009	3.41	2.97

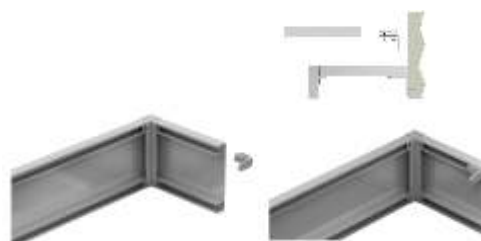

Escuadra Unión Laterales



Ref.	€ud	 (50)
2007005	3.29	2.86



Galería de Aluminio



CARTA DE COLORES

LACADOS



Blanco Brillo

Natural

Gris Medio

Dorado

Visión

METÁLICOS



Titanio

Brillo Grata

Negro Grata

MADERAS

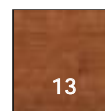

Cerezo

ACCESORIOS

Empalme Perfil



Ref.	Color	€ud	(20)
2007004	08	10.36	9.01
	03		
	12		
	01		
	11		
	57		



Tapón Instalación Pared



Ref.	Color	€ud	(20)
2007008	08	7.92	6.89
	03		
	12		
	01		
	11		
	57		



Terminal Tapón



Ref.	Color	€ud	(20)
2007007	08	7.92	6.89
	03		
	12		
	01		
	11		
	57		



PVP IVA no incluido



Galería de Aluminio Vinilos



COLOR



BRILLO GRATA

SE FACTURA tira completa de 3.00 metros.
Perfil máximo 3.00 metros, a partir de esta medida será necesario empalme.
Posibilidad de corte A MEDIDA (no incrementa el precio).

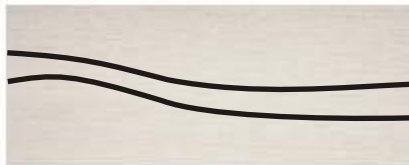

VINILO RAYAS

REF:	color	€/ud/3 m
2127001	0812	179.64



VINILO CUADROS NEGRO

REF:	color	€/ud/3 m
2137001	0812	179.64



VINILO CUADROS BLANCO

REF:	color	€/ud/3 m
2137001	0801	179.64



ACCESORIOS

COLOR

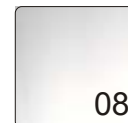

08

BRILLO GRATA

Cantonera



Ref.	Color	€ud	 (20)
2007001	08	16.95	14.74

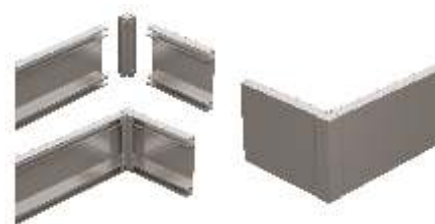

Empalme embellecedor



Ref.	Color	€ud	 (20)
2007002	08	10.81	9.40

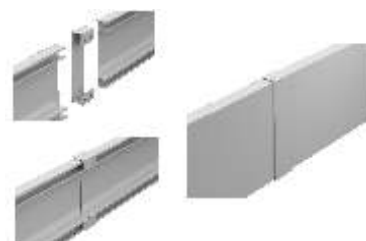

Empalme Articulado



Ref.	Color	€ud	 (10)
2007003	08	43.64	37.95

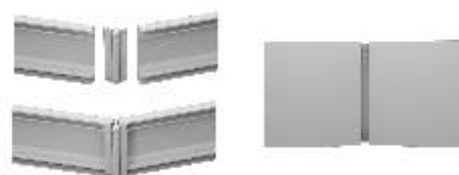

Soporte Palanca



Ref.	Color	€ud	 (200)
3207001	08	0.68	0.59





ESCUADRAS

ESCUADRA PARED ALUMINIO



* TORNILLO LARGO M:4x10 mm
PARA INSTALACION CON
SOPORTES DE MAYOR GROSOR



Ref.	Medida	1	€/ud		€/ud		€/ud		€/ud	
			(25)	(25)	(25)	(25)	(25)	(25)		
6117000	5 cm	1	2.82	2.45	3.23	2.81	3.23	2.81	3.23	2.81
	8 cm	1	3.28	2.85	3.76	3.27	3.76	3.27	3.76	3.27
	12 cm	1	4.03	3.50	4.63	4.03	4.63	4.03	4.63	4.03
	16 cm	2	5.73	4.98	6.58	5.72	6.58	5.72	6.58	5.72
	20 cm	2	6.38	5.55	7.34	6.38	7.34	6.38	7.34	6.38
			Color 01 Blanco Brillo		Color 03 Titanio		Color 04 Lacado Plata		Color 12 Negro	

TUERCA CON TORNILLO ESCUADRA

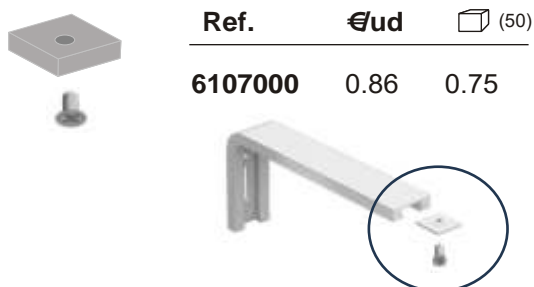

Ref.	€/ud	(50)
6107000	0.86	0.75

EXTENSIÓN ESCUADRA DE ALUMINIO



Ref.	€/ud	(25)
6107001	2.21	1.92

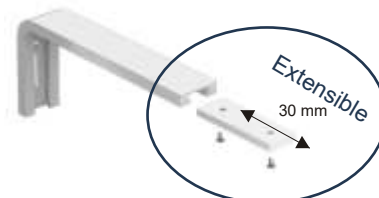

EMBELLECEDOR ESCUADRA DE ALUMINIO



Ref.	€/ud	(25)
6137000	01 Blanco	8.67 7.54
	03 Titanio	9.19 7.99
	04 Lacado Plata	9.19 7.99
	12 Negro	9.19 7.99

PROYECCIÓN VALENCIA

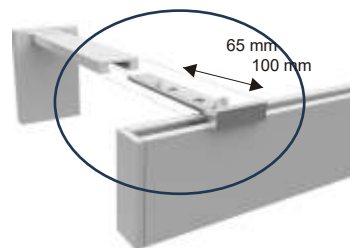

Ref.	€/ud	(25)
6107002	65 mm. 01 Blanco	
	65 mm. 03 Titanio	5.74 4.99
	65 mm. 04 Lacado Plata	
	65 mm. 12 Negro	
6107003	100 mm. 01 Blanco	
	100 mm. 03 Titanio	8.04 6.99
	100 mm. 04 Lacado Plata	
	100 mm. 12 Negro	

PVP IVA no incluido



ESTORES





Estor Oculto

SISTEMA MONTADO A MEDIDA

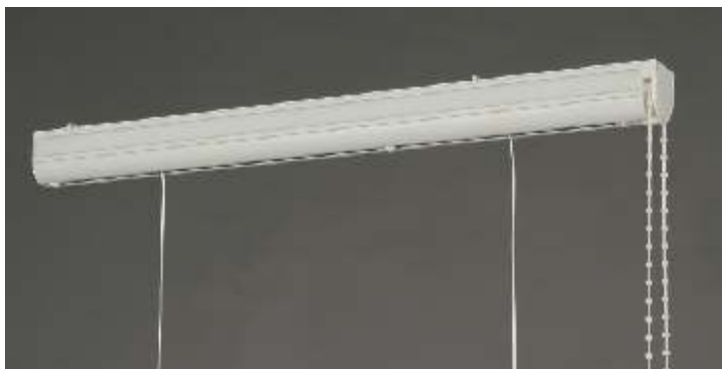

COMPONENTES:

Perfil velcroado (**3107000**)
Juego Comando + Tapa
Conjunto cono + cordón (270 cm)
Barra transmisora
Pletina Contrapeso 25x3 mm
Tapas Pletina (2)
Soporte Techo (**3107005**)
Anillo Cadena (2.5 m)
Mosquetón
Cinta cierre Hembra
Contrapeso (**3007000**)

Opción de poder modificar nº de guías, soportes, pletina.
Consultar otras opciones.
Opciones no incluido en PVP standard

ESTOR PAQUETO

color



Embalaje bolsa. Cinta de estor no incluida.

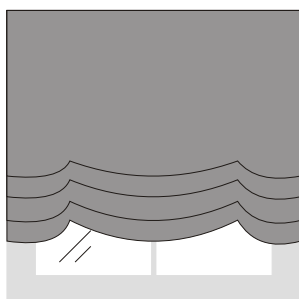

Ref:	Medida	guías	soportes	€/ud
	80	2	2	40
	100	2	2	44
	120	2	2	47
	140	3	3	56
3118000	160	3	3	59
	180	4	4	69
	200	4	4	72
	220	4	4	76

Medida en cm para medidas especiales 15% de incremento.



ACCESORIOS

Perfil Estor (5.8 m)

Aluminio
Blanco
34x3 mm



Ref.	€ud	 (58)
3107000	13.00	11.30

Juego Comando

Blanco
34x32 mm



Ref.	€ud	 (50)
3107001 1.1 rápido	7.94	6.90
3107002 1.4 lento	7.94	6.90

Conjunto Cono con Cordón

Blanco/Transparente



Ref.	€ud	 (100)
3107004	4.49	3.90

Conjunto Cono

Blanco/Transparente



Ref.	€ud	 (100)
3107003	4.07	3.56

Soporte Techo

Acero
Blanco



Ref.	€ud	 (100)
3107005	0.85	0.74

Contrapeso 21 gr

Transparente
Blanco



Ref.	€ud	 (50)
3007000 Blanco	1.73	1.50
3007001 Transparente	1.73	1.50



Estor Oculto

ACCESORIOS

Cadena

Plástico
Blanco
4.5x4.5 mm



Ref.	€/ud	 (200)
3007002	1.68	1.40

Anillo Cadena

Plástico
Blanco
4.5x4.5 mm



Ref.	Medida	€/ud	 (10)
3007003	2 m	2.98	2.48
	2.5 m	3.59	2.99
	3 m	4.50	3.91
	3.5 m	5.43	4.72

Anillo cadena

Metálico
Acero
4.5x4.5 mm



Ref.	Medida	€/ud	 (10)
3007004	2.5 m	4.90	4.30
	3 m	5.70	4.90

Empalme cadena

Plástico
Blanco



Ref.	€/ud	 (100)
3007005	0.30	0.26

Empalme cadena

Metálico
Acero



Ref.	€/ud	 (100)
3007006	1.02	0.88



ACCESORIOS

Barra transmisora

Aluminio
4x4 mm



Ref.	€ud	 (120)
3007007	2.19	1.90

Pletina Contrapeso

Aluminio
Blanco
25x3 mm



Ref.	€ud	 (90)
3007008	25x3 mm 4.78	4.16

Tapa Pletina Contrapeso

Plástico
Transparente
25x3 mm



Ref.	€ud	 (500)
3007009	25x3 mm 0.14	0.12

Varilla Fibra de Vidrio

Fibra de Vidrio
Blanco
4x4 mm



Ref.	€ud	 (600)
3007010	0.37	0.32

Cinta Velcro Adhesiva (macho)

Blanco
20 mm



Ref.	€ud	 (25)
77010	1.10	0.90

Cinta Velcro (hembra)

Blanco
20 mm



Ref.	€ud	 (25)
77011	0.51	0.44



Estor Oculto

ACCESORIOS

Cinta con Anilla

Poliéster
Transparente
17 mm



Ref.	€ud	 (150)
3007011	1.46	1.24

Cinta para Varilla Fibra

Poliéster
Blanco
17 mm.



Ref.	€ud	 (300)
3007012	0.64	0.54

Mosquetón

Metálico



Ref.	€ud	 (60)
3007013	0.22	0.19

Estor Cadena Basic



SISTEMA MONTADO A MEDIDA

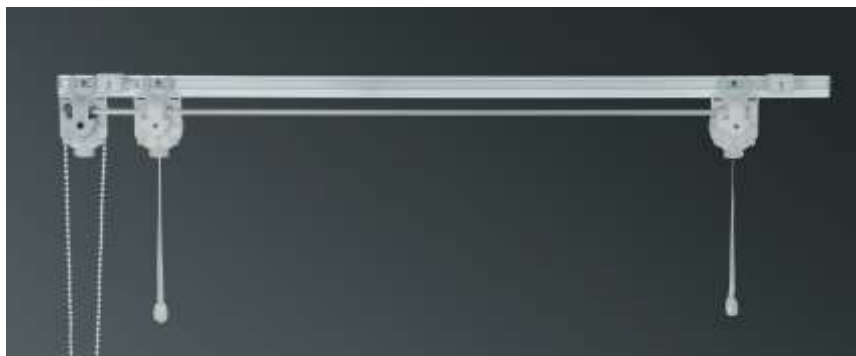

COMPONENTES:

Perfil velcroado (3207000)
 Freno Cadena
 Barra transmisora
 Terminal Tapón
 Pletina Contrapeso 25x3 mm
 Tapas Pletina (2)
 Galón Transparente (270 cm)
 Soporte Palanca
 Anillo Cadena (2.5 m)
 Mosquetón
 Cinta cierre Hembra
 Varilla Estor
 Contrapeso (3007000)

Opción de poder modificar nº de guías, soportes, pletina.
 Consultar otras opciones.
 Opciones no incluido en PVP standard

ESTOR PLEGABLE CON VARILLAS



color

Embalaje bolsa. Varillas incluidas. Cinta de estor no incluida.

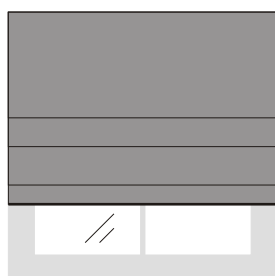

Ref:	Medida	guías	soportes	€/ud
3218000	80	2	2	36
	100	2	2	39
	120	2	2	41
	140	3	3	50
	160	3	3	53
	180	4	4	63
	200	4	4	65
	220	4	4	68

Medida en cm para medidas especiales 15% de incremento.

ESTOR PAQUETO



color

Embalaje bolsa. Cinta de estor no incluida.

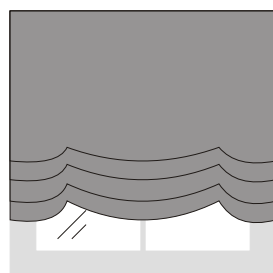

Ref:	Medida	guías	soportes	€/ud
3218001	80	2	2	34
	100	2	2	36
	120	2	2	39
	140	3	3	47
	160	3	3	49
	180	4	4	59
	200	4	4	61
	220	4	4	63

Medida en cm para medidas especiales 15% de incremento.



Estor Cadena Basic

ACCESORIOS

Perfil Estor

Aluminio
Blanco
10x23 mm



Ref.	€ud	 (120)
3207000	5.29	4.60

Freno Cadena

Blanco
1.1 Rápido/2 Kg
1.5 Lento/5.5 Kg



Ref.	€ud	 (30)	
3217001	1.1 Rápido	5.41	4.70
3217002	1.5 Lento	5.41	4.70

Guía Cadena

Blanco



Ref.	€ud	 (60)
3217003	4.99	4.30

Guía Cadena con Mosquetón

Blanco



Ref.	€ud	 (60)
3217004	5.91	5.14

Cinta Velcro Adhesiva (macho)

Blanco
20 mm



Ref.	€ud	 (25)
77010	1.10	0.90

Cinta Velcro (hembra)

Blanco
20 mm



Ref.	€ud	 (25)
77011	0.51	0.44

Estor Cadena Basic



ACCESORIOS

Barra transmisora

Aluminio
4x4 mm



Ref.	€ud	 (120)
3007007	2.19	1.90

Pletina Contrapeso

Aluminio
Blanco
25x3 mm



Ref.	€ud	 (90)
3007008	25x3 mm 4.78	4.16

Tapa Pletina Contrapeso

Plástico
Transparente
25x3 mm



Ref.	€ud	 (500)
3007009	25x3 mm 0.14	0.12

Varilla Fibra de Vidrio

Fibra de Vidrio
Blanco
4x4 mm



Ref.	€ud	 (600)
3007010	0.37	0.32

Terminal Tapón

Blanco
10x20 mm



Ref.	€ud	 (200)
3207005	0.14	0.12

Contrapeso 21 gr

Transparente
Blanco



Ref.	€ud	 (50)
3007000	Blanco 1.73	1.50
3007001	Transparente 1.73	1.50



Estor Cadena Basic

ACCESORIOS

Cadena

Plástico
Blanco
4.5x4.5 mm



Ref.	€ud	 (200)
3007002	1.68	1.40

Anillo Cadena

Plástico
Blanco
4.5x4.5 mm



Ref.	Medida	€ud	 (10)
3007003	2 m	2.98	2.48
	2.5 m	3.59	2.99
	3 m	4.50	3.91
	3.5 m	5.43	4.72

Anillo cadena

Metálico
Acero
4.5x4.5 mm



Ref.	Medida	€ud	 (10)
3007004	2.5 m	4.90	4.30
	3 m	5.70	4.90

Empalme cadena

Plástico
Blanco



Ref.	€ud	 (100)
3007005	0.30	0.26

Empalme cadena

Metálico
Acero



Ref.	€ud	 (100)
3007006	1.02	0.88

Estor Cadena Basic



ACCESORIOS

Cinta con Anilla

Transparente
17 mm



Ref.	€ud	 (150)
3007011	1.46	1.24

Cinta para Varilla

Poliéster
Blanco
17 mm



Ref.	€ud	 (300)
3007012	0.64	0.54

Galón Guía

Poliéster
Transparente
4.5x4.5 mm



Ref.	€ud	 (150)
3217000	0.33	0.28

Mosquetón

Acero
4.5x4.5 mm



Ref.	€ud	 (200)
3007013	0.22	0.19

Soporte Palanca Techo

3207001



Soporte Palanca Universal

3207002 (4 cm)



3207003 (6 cm)



Plástico/Blanco

Ref.	€ud	 (200)
3207002	0.82	0.70
3207003	0.90	0.78
3207001	0.68	0.59

Soporte Universal

Plástico
Blanco



Ref.	€ud	 (200)
3207004	0.58	0.49



Estor Cordón

SISTEMA MONTADO A MEDIDA



COMPONENTES:

Perfil velcro (3207000)
 Freno Cordón
 Guía + Anilla Final
 Terminal Tapón
 Pletina Contrapeso 25x3 mm
 Tapas Pletina (2)
 Soporte Palanca
 Bola Tapanudos plástico
 Cordón 1.5 (270 cm)
 Cordón 2.5 mm
 Cinta cierre Hembra
 Varilla Estor (opcional)

Opción de poder modificar nº de guías, soportes, pletina.
 Consultar otras opciones.
 Opciones no incluido enl PVP standard

ESTOR PLEGABLE CON VARILLAS



color

Embalaje bolsa. Varillas incluidas. Cinta de estor no incluida.

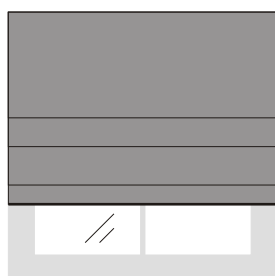

Ref:	Medida	guías	soportes	€/ud
3228000	80	2	2	18
	100	2	2	21
	120	2	2	23
	140	3	3	27
	160	3	3	29
	180	4	4	34
	200	4	4	36
	220	4	4	39

Medida en cm para medidas especiales 15% de incremento.

ESTOR PAQUETO



color

Embalaje bolsa. Cinta de estor no incluida.

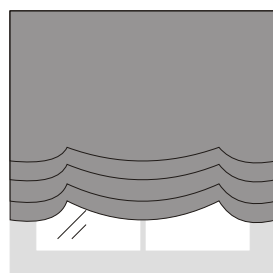

Ref:	Medida	guías	soportes	€/ud
3228001	80	2	2	16
	100	2	2	20
	120	2	2	22
	140	3	3	25
	160	3	3	27
	180	4	4	31
	200	4	4	33
	220	4	4	35

Medida en cm para medidas especiales 15% de incremento.



ACCESORIOS

Perfil Estor

Aluminio
Blanco
10x23 mm



Ref.	€ud	 (120)
3207000	5.29	4.60

Freno Cordón

Plástico/Metal
Blanco



Ref.	€ud	 (60)
3227000	1.61	1.40

Guía Cordón

Blanco



Ref.	€ud	 (200)
3227001	0.32	0.28

Anilla Final

Blanco



Ref.	€ud	 (200)
3227002	0.04	0.033

Cinta Velcro Adhesiva (macho)

Blanco
20 mm



Ref.	€ud	 (25)
77010	1.10	0.90

Cinta Velcro (hembra)

Blanco
20 mm



Ref.	€ud	 (25)
77011	0.51	0.44



Estor Cordón

ACCESORIOS

Tirador

Plástico
Blanco
4x4 mm



Ref.	€ud	 (120)
3227003	0.31	0.27

Pletina Contrapeso

Aluminio
Blanco
25x3 mm



Ref.	€ud	 (60)
3007008	25x3 mm 4.78	4.16

Tapa Pletina Contrapeso

Plástico
Transparente
25x3 mm



Ref.	€ud	 (500)
3007009	25x3 mm 0.14	0.12

Varilla Fibra de Vidrio

Fibra de Vidrio
Blanco
4 mm Ø



Ref.	€ud	 (600)
3007010	0.37	0.32

Terminal Tapón

Blanco
10X23 mm



Ref.	€ud	 (200)
3207005	0.14	0.12

Bola Tapanudos

Metal/Plástico
Blanco



Ref.	€ud	 (200)
3227004	Plástico 0.67	0.58
3227005	Aluminio 0.78	0.68



ACCESORIOS

Cinta con Anilla

Poliéster
Transparente
17 mm



Ref.	€ud	 (120)
3007011	1.46	1.24

Cinta para Varilla

Poliéster
Blanco
17 mm



Ref.	€ud	 (60)
3007012	0.64	0.54

Soporte Palanca Techo

3207001



Soporte Palanca Universal

3207002 (4 cm)



3207003 (6 cm)



Plástico/Blanco

Ref.	€ud	 (200)
3207002	0.82	0.70
3207003	0.90	0.78
3207001	0.68	0.59

Soporte Universal

Plástico
Blanco



Ref.	€ud	 (200)
3207004	0.58	0.49



ESCUADRAS

ESCUADRA PARED ALUMINIO



* TORNILLO LARGO M4x10 mm
PARA INSTALACION CON
SOPORTES DE MAYOR GROSOR



Ref.	Medida	1	€/ud		€/ud		€/ud		€/ud	
			(25)	(25)	(25)	(25)	(25)	(25)		
6117000	5 cm	1	2.82	2.45	3.23	2.81	3.23	2.81	3.23	2.81
	8 cm	1	3.28	2.85	3.76	3.27	3.76	3.27	3.76	3.27
	12 cm	1	4.03	3.50	4.63	4.03	4.63	4.03	4.63	4.03
	16 cm	2	5.73	4.98	6.58	5.72	6.58	5.72	6.58	5.72
	20 cm	2	6.38	5.55	7.34	6.38	7.34	6.38	7.34	6.38
			Color 01 Blanco Brillo		Color 03 Titanio		Color 04 Lacado Plata		Color 12 Negro	

TUERCA CON TORNILLO ESCUADRA

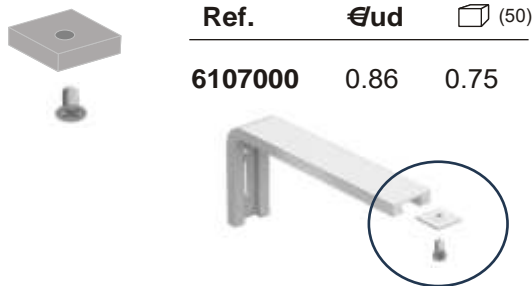

Ref.	€/ud	(50)
6107000	0.86	0.75

EXTENSION ESCUADRA DE ALUMINIO



Ref.	€/ud	(25)
6107001	2.21	1.92

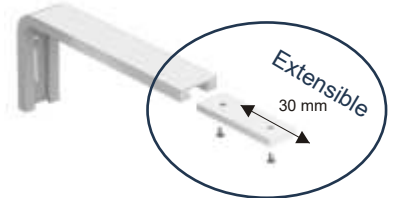

EMBELLECEDOR ESCUADRA DE ALUMINIO

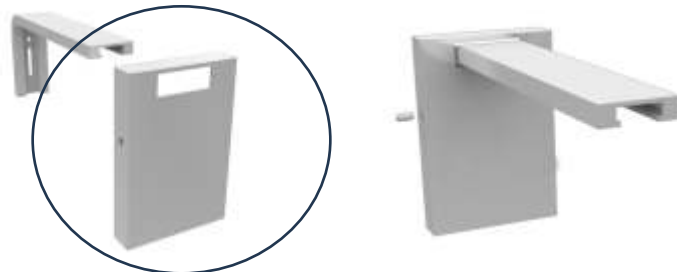

Ref.	€/ud	(25)
6137000	01 Blanco	8.67 7.54
	03 Titanio	9.19 7.99
	04 Lacado Plata	9.19 7.99
	12 Negro	9.19 7.99

PROYECCIÓN VALENCIA

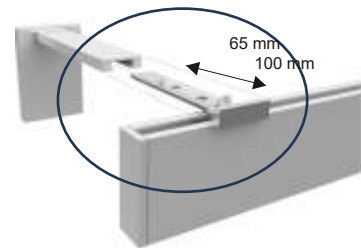

Ref.	€/ud	(25)
6107002	65 mm. 01 Blanco	
	65 mm. 03 Titanio	5.74 4.99
	65 mm. 04 Lacado Plata	
	65 mm. 12 Negro	
6107003	100 mm. 01 Blanco	
	100 mm. 03 Titanio	8.04 6.99
	100 mm. 04 Lacado Plata	
	100 mm. 12 Negro	

PVP IVA no incluido

ESCUADRAS



ESCUADRA PARED ROSCADA



Ref.	Medida	€ud	(50)
6207000	45 mm	1.92	1.67
	90 mm	2.54	2.21
	150 mm	3.49	2.91
	180 mm	4.06	3.38

SOPORTE INSTALACIÓN SIN AGUJEROS



Blanco



Gris

Soporte Instalación Techo



AJUSTABLE
AL GROSOR
DEL VENTANAL

Ref.	€ud	(25)
6307001	7.50	6.52
	7.50	6.52



PARTE FRONTAL



PARTE TRASERA

Soporte Instalación Pared



AJUSTABLE
AL GROSOR
DEL VENTANAL

Ref.	€ud	(25)
6307001	7.50	6.52
	7.50	6.52



PARTE FRONTAL



PARTE TRASERA

Tuerca con tornillo Fijación riel soporte techo

Ref.	€ud	(25)
6307002	0.98	0.78



Tuerca con tornillo Fijación riel soporte pared

Ref.	€ud	(25)
6307003	0.08	0.07



PVP IVA no incluido





PANEL
2/3/4/5 VÍAS





Panel Japonés

SISTEMA MONTADO A MEDIDA



Componentes:

- Perfil aluminio 2 vías.
- Tapas final.
- Portatelas
- Tapa portatelas
- Pletina contrapeso 40x3 mm
- Tapa pletina
- Angular simple/doble
- Soporte portatelas
- Unión blocacuerda
- Tornillo tope
- Contrapeso cordón
- Cordón 3.5 mm
- Soporte panel techo (1cada 70 cm)
- Cinta velcro hembra

MANUAL LIBRE



MANUAL ENLAZADO

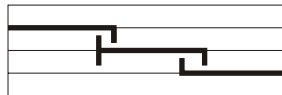

CORDÓN

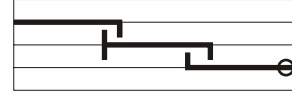

Medida en €/cm

	REF.	100	175	200	225	250	300	350
CORDÓN	4128300	66	74	84	93	101	121	137
MANUAL	4128200							
LIBRE	4128100	59	67	75	83	91	109	123

OPCIONES RECOGIDA

Ref.		€/ud
4108000	Sist. Panel cierre centro (DOBLE PORTATELAS)	11.20
4108001	Sist. Panel Doble Mando	11.20



Panel Japonés



SISTEMA MONTADO A MEDIDA



Componentes:

- Perfil aluminio 3 vías.
- Tapas final.
- Portatelas
- Tapa portatelas
- Pletina contrapeso 40x3 mm
- Tapa pletina
- Angular simple/doble
- Soporte portatelas
- Unión blocacuerda
- Tornillo tope
- Contrapeso cordón
- Cordón 3.5 mm
- Soporte panel techo (1cada 70 cm)
- Cinta velcro hembra

MANUAL LIBRE



MANUAL ENLAZADO

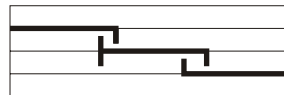

CORDÓN

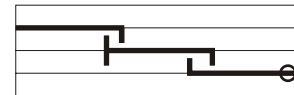

Medida en €/cm

	REF.	150	175	200	225	250	300	350	400	500	600
CORDÓN	4138300	69	79	89	98	108	128	145	165	217	233
MANUAL	4138200	62	71	80	89	97	115	131	149	195	210
LIBRE	4138100										

OPCIONES RECOGIDA

Ref.		€/ud
4108000	Sist. Panel cierre centro (DOBLE PORTATELAS)	11.20
4108001	Sist. Panel Doble Mando	11.20

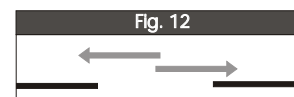
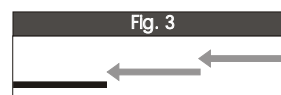



Panel Japonés

SISTEMA MONTADO A MEDIDA



Componentes:

- Perfil aluminio 4 vías.
- Tapas final.
- Portatelas
- Tapa portatelas
- Pletina contrapeso 40x3 mm
- Tapa pletina
- Angular simple/doble
- Soporte portatelas
- Unión blocacuerda
- Tornillo tope
- Contrapeso cordón
- Cordón 3.5 mm
- Soporte panel techo (1 cada 70 cm)
- Cinta velcro hembra

MANUAL LIBRE



MANUAL ENLAZADO

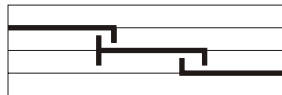

CORDÓN

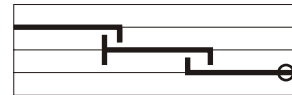

Medida en €/cm

	REF.	150	175	200	225	250	300	350	400	500	600
CORDÓN	4148300	79	90	101	112	123	146	166	200	251	268
MANUAL	4148200	71	81	91	101	111	132	150	180	226	241
LIBRE	4148100										

OPCIONES RECOGIDA

Ref.		€/ud
4108000	Sist. Panel cierre centro (DOBLE PORTATELAS)	11.20
4108001	Sist. Panel Doble Mando	11.20



Panel Japonés



SISTEMA MONTADO A MEDIDA



Componentes:

- Perfil aluminio 5 vías.
- Tapas final.
- Portatelas
- Tapa portatelas
- Pletina contrapeso 40x3 mm
- Tapa pletina
- Angular simple/doble
- Soporte portatelas
- Unión blocacuerda
- Tornillo tope
- Contrapeso cordón
- Cordón 3.5 mm
- Soporte panel techo (1 cada 70 cm)
- Cinta velcro hembra

MANUAL LIBRE



MANUAL ENLAZADO

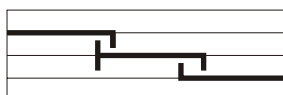

CORDÓN

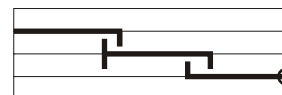

Medida en €/cm

	REF.	150	175	200	225	250	300	350	400	500	600
CORDÓN	4148300	87	99	112	124	136	162	184	223	281	298
MANUAL LIBRE	4148200	83	94	102	118	129	148	152	203	247	284
	4148100										

OPCIONES RECOGIDA

Ref.		€/ud
4108000	Sist. Panel cierre centro (DOBLE PORTATELAS)	11.20
4108001	Sist. Panel Doble Mando	11.20

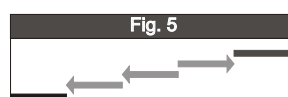



Panel Japonés

ACCESORIOS PANEL

Perfil 2 Vías

Aluminio
Blanco
37X15.5 mm



Ref.	€ud	 (60)
4107002	16,00	

Perfil 3 Vías

Aluminio
Blanco
55X15.5 mm



Ref.	€ud	 (60)
4107003	18,50	

Perfil 4 Vías

Aluminio
Blanco
73X15.5 mm



Ref.	€ud	 (60)
4107004	24,00	

Perfil 5 Vías

Aluminio
Blanco
91X15.5 mm



Ref.	€ud	 (60)
4107005	28,90	

Tapa 2 Vías

Blanco



Ref.	€ud	 (20)
4107006	1,81	

Tapa 3 Vías

Blanco



Ref.	€ud	 (50)
4107007	1,85	

Panel Japonés



ACCESORIOS PANEL

Tapa 4 Vías

Blanco



Ref.	€ud	 (20)
4107008	2,85	

Tapa 5 Vías

Blanco



Ref.	€ud	 (20)
4107009	3,30	

Portatelas

Aluminio
Blanco



Ref.	€ud	 (60)
4107010	8,30	

Soporte Portatelas

Blanco



Ref.	€ud	 (200)
4107011	0.44	0.38

Soporte Techo

Blanco



Ref.	€ud	 (100)
4107000	2 /3 vías	0.86
4107001	4 /5 vías	0.92

Cinta Velcro (hembra)

Blanco
20 mm



Ref.	€ud	 (25)
77011	0.51	0.44



Panel Japonés

ACCESORIOS PANEL

Tapa Portatelas

Blanco



Ref.	€ud	 (200)
4107012	0.99	0.86

Unión Blocacuerda

Blanco



Ref.	€ud	 (50)
4107013	1.02	0.88

Angular Simple

Blanco



Ref.	€ud	 (100)
4107015	0.39	0.34

Angular Doble

Blanco



Ref.	€ud	 (100)
4107014	0.44	0.38

Pletina Contrapeso

Aluminio
Blanco
40x3 mm



Ref.	€ud	 (90)
4107016	6.79	5.90

Tapa pletina

Plástico
Transparente
42x5 mm



Ref.	€ud	 (500)
4107017	0.25	0.22



ACESORIOS PANEL

Contrapeso 90 gr

Blanco



Ref.	€ud	 (50)
4107018	1.84	1.60

Enganche Tirador

Blanco



Ref.	€ud	 (100)
4107019	1.38	1.20

Tirador Plastificado Blanco 1 m



Ref.	€ud	 (25)
77007	4.50	3.95

Tornillo Tope

Acero



Ref.	€ud	 (100)
4107020	0.34	0.30

Cordón 3 mm

Blanco
3x3 mm



Ref.	€ud	 (60)
77012	0.32	0.28



Panel Japonés

ESCUADRA PARED ALUMINIO



* TORNILLO LARGO M:4x10 mm
PARA INSTALACION CON
SOPORTES DE MAYOR GROSOR



Ref.	Medida	1	€/ud		€/ud		€/ud		€/ud	
			(25)	(25)	(25)	(25)	(25)	(25)		
6117000	5 cm	1	2.82	2.45	3.23	2.81	3.23	2.81	3.23	2.81
	8 cm	1	3.28	2.85	3.76	3.27	3.76	3.27	3.76	3.27
	12 cm	1	4.03	3.50	4.63	4.03	4.63	4.03	4.63	4.03
	16 cm	2	5.73	4.98	6.58	5.72	6.58	5.72	6.58	5.72
	20 cm	2	6.38	5.55	7.34	6.38	7.34	6.38	7.34	6.38
			Color 01 Blanco Brillo		Color 03 Titanio		Color 04 Lacado Plata		Color 12 Negro	

TUERCA CON TORNILLO ESCUADRA

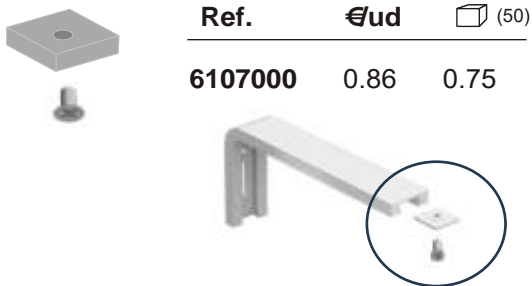

Ref.	€/ud	(50)
6107000	0.86	0.75

EXTENSIÓN ESCUADRA DE ALUMINIO



Ref.	€/ud	(25)
6107001	2.21	1.92

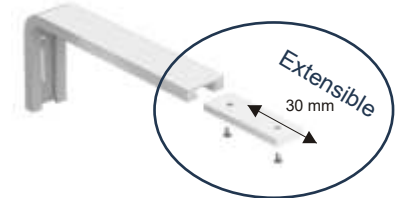

EMBELLECEDOR ESCUADRA DE ALUMINIO

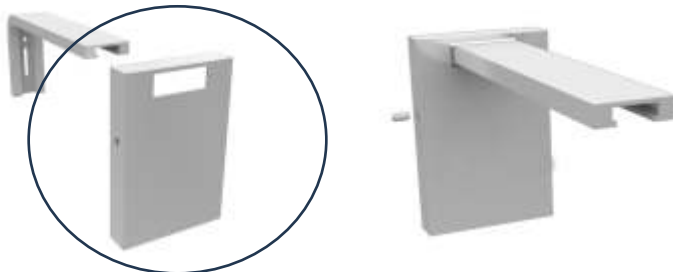

Ref.	€/ud	(25)
6137000	01 Blanco	8.67 7.54
	03 Titanio	9.19 7.99
	04 Lacado Plata	9.19 7.99
	12 Negro	9.19 7.99

PROYECCIÓN VALENCIA

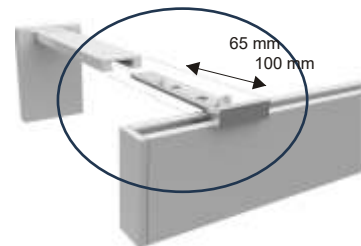

Ref.	€/ud	(25)
6107002	65 mm. 01 Blanco	
	65 mm. 03 Titanio	5.74 4.99
	65 mm. 04 Lacado Plata	
	65 mm. 12 Negro	
6107003	100 mm. 01 Blanco	
	100 mm. 03 Titanio	8.04 6.99
	100 mm. 04 Lacado Plata	
	100 mm. 12 Negro	

PVP IVA no incluido

ESCUADRAS



ESCUADRA PARED ROSCADA



Ref.	Medida	€ud	(50)
6207000	45 mm	1.92	1.67
	90 mm	2.54	2.21
	150 mm	3.49	2.91
	180 mm	4.06	3.38

SOPORTE INSTALACIÓN SIN AGUJEROS



Blanco



Gris

Soporte Instalación Techo



Ref.	€ud	(25)
6307001	7.50	6.52
	7.50	6.52



PARTE FRONTAL



PARTE TRASERA

Soporte Instalación Pared



Ref.	€ud	(25)
6307001	7.50	6.52
	7.50	6.52



PARTE FRONTAL



PARTE TRASERA

Tuerca con tornillo Fijación riel soporte techo

Ref.	€ud	(25)
6307002	0.98	0.78



Tuerca con tornillo Fijación riel soporte pared

Ref.	€ud	(25)
6307003	0.08	0.07



PVP IVA no incluido





Enrollables

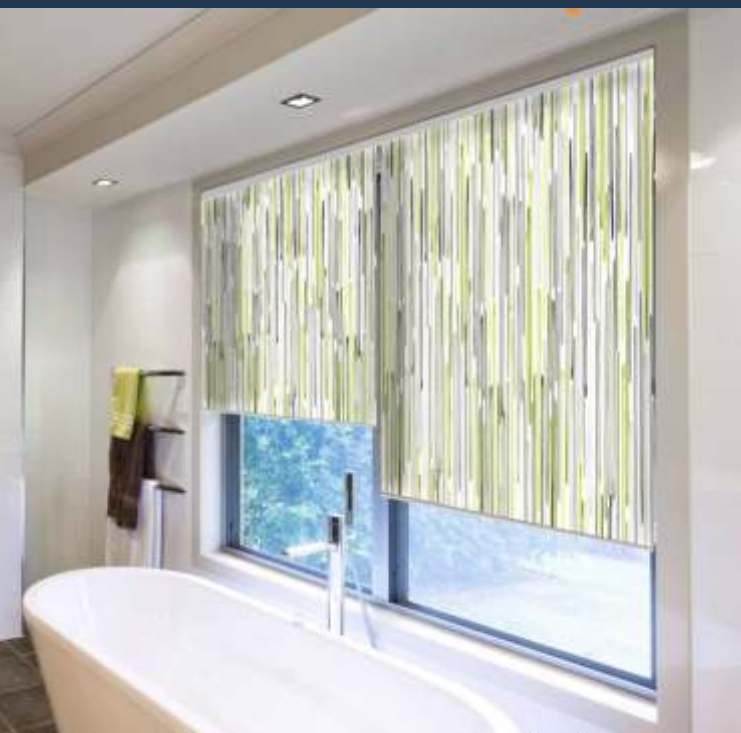



Serie Minitech (tubo 18 Ø mm)

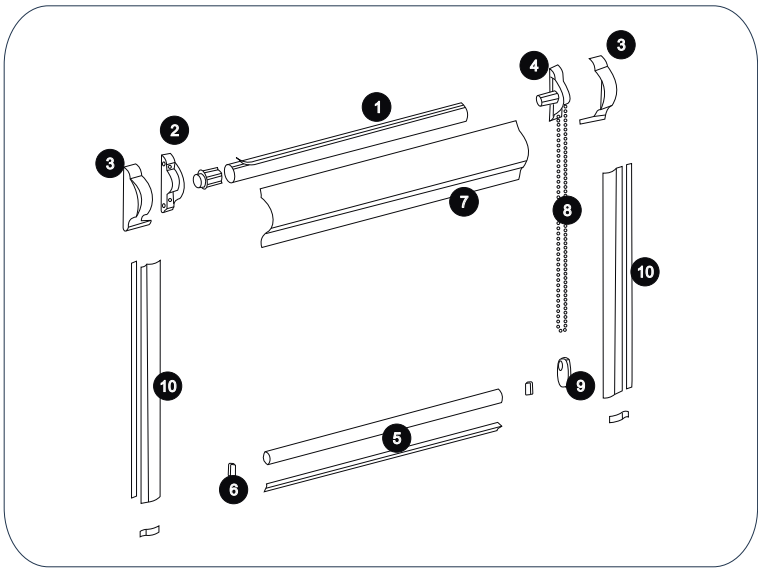

- 1 Tubo
- 2 Juego de soportes
- 3 Juego de tapas
- 4 Comando
- 5 Contrapeso
- 6 Tapa contrapeso
- 7 Cajón
- 8 Cadena
- 9 Contrapeso cadena
- 10 Guías laterales

ANCHO

ALTO

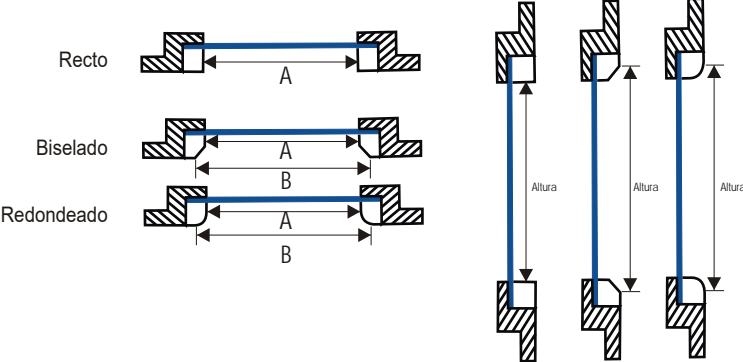

Como Tomar Medidas

ANCHO: Hay tres tipos de junquillo (recto, biselado o redondeado). Para el recto tomaremos medida A para el biselado y redondeado A y B (según dibujo).

ALTO: Para la altura tomaremos la medida según dibujo.



Serie Slim (tubo 43-48 Ø mm Reforzado)

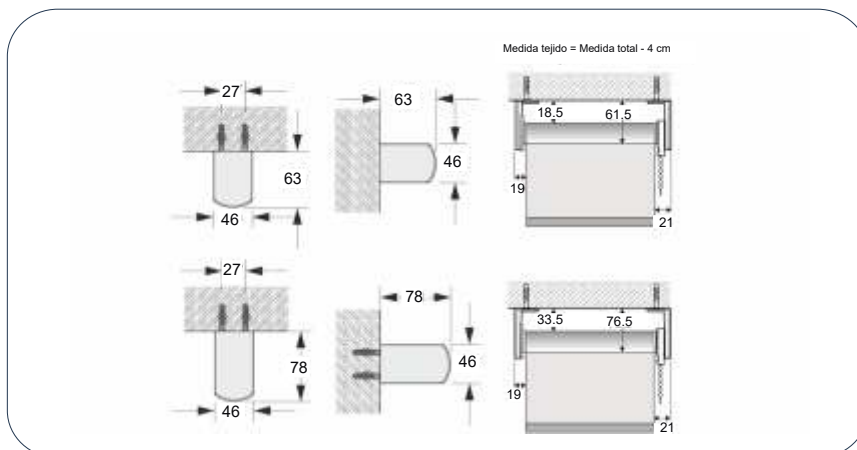
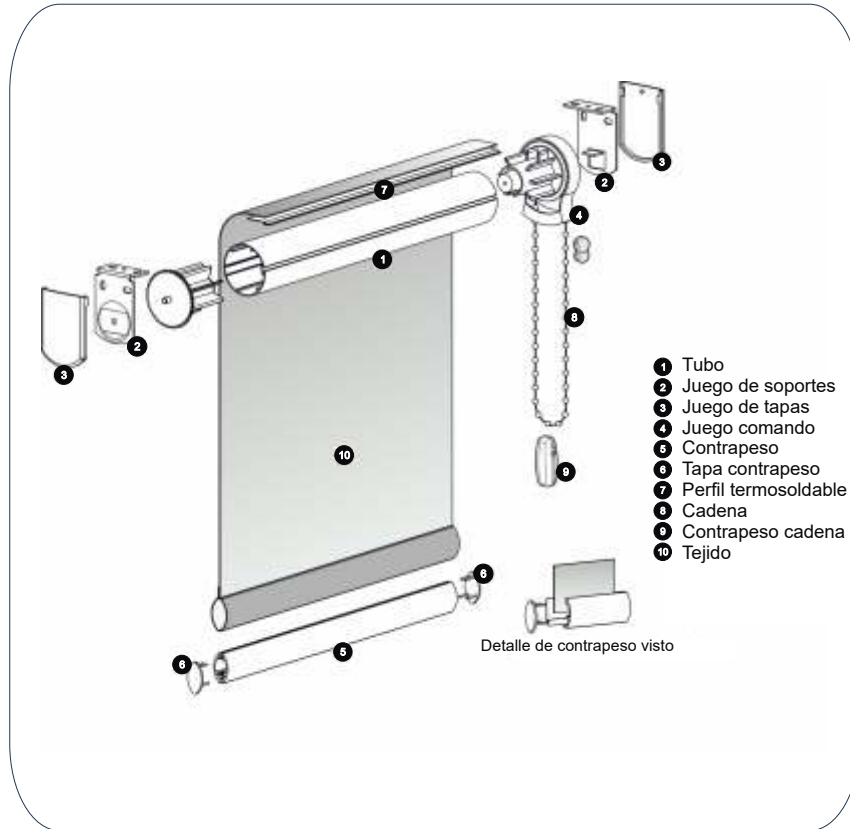

Mecanismo

	Ø 43mm				Ø 48mm Reforzado	
En €	100	140	180	220	260	300
	72	79	86	96	109	118

Incluye todos los elementos excepto el tejido. Medidas del total del mecanismo con soportes y embellecedores, en cm.



Enrollable / Lama Panel / Minittech

Grupo 1

Loneta resinada Shantung

Composición y medidas pg. TEJIDOS

ENROLLABLE Desmultiplicador 4,5 Kg

	Tubo de Ø 43 mm								48 Ø mm Reforzado			
	100	120	140	160	180	200	220	240	260	280	300	
100	78	92	95	98	101	107	115	126	100	140	150	157
120	81	95	99	103	106	112	121	132	120	147	158	165
140	84	99	103	107	110	117	127	139	140	154	165	173
160	86	102	107	111	115	122	132	145	160	160	173	180
180	89	106	111	115	119	127	138	151	180	167	180	188
200	92	109	115	120	124	132	143	157	200	174	187	196
220	95	113	119	124	129	137	149	164	220	181	195	204
240	97	116	123	128	133	142	154	170	240	187	202	212
260	100	120	126	132	138	147	160	176	260	194	210	220
280	103	124	130	137	142	152	166	183	280	201	217	228
300	106	127	134	141	147	157	171	189	300	208	225	236

Medidas del total del enrollable con soportes incluidos en cm. Para medidas superiores consultar

PANEL JAPONÉS

	60	80	100	120
100	37	40	45	47
120	39	41	47	50
140	40	43	49	53
160	41	45	52	55
180	43	47	54	58
200	44	48	56	61
220	45	50	58	63
240	47	52	61	66
260	48	54	63	69
280	50	55	65	72
300	51	57	68	74

MINITECH

	60	80	100	120
100	120	131	141	152
120	125	136	148	159
140	131	142	154	165
160	136	148	160	172
180	142	154	166	179
200	147	160	173	186

Si el ancho del enrollable es superior al ancho del tejido, deberá confeccionarse dándole la vuelta al tejido. Esto puede derivar en otro método de fabricación. Si dándole la vuelta al tejido no se cubre el alto deseado, se empalmará el tejido (horizontalmente y en la parte superior).

Dar la vuelta al tejido puede provocar aguas y los laterales del tejido del enrollable extendido pueden deformarse hacia delante o hacia atrás, no siendo este motivo de reclamación. Para todos estos casos, se entenderá que el cliente final ha sido informado y que se tiene su **autorización expresa** para la fabricación.

Enrollable / Lama Panel / Minittech



Composición y medidas pg. TEJIDOS

Grupo 2

P3000 PE10 ECOLOGIC	LINO 100 OPACO NORUEGA
------------------------------------	-----------------------------------

ENROLLABLE Desmultiplicador 4,5 Kg

Tubo de Ø 43 mm									48 Ø mm Reforzado			
	100	120	140	160	180	200	220	240		260	280	300
100	102	121	127	132	150	157	164	186	100	200	205	212
120	108	128	134	141	160	168	176	199	120	214	220	228
140	113	135	142	149	170	178	187	212	140	229	236	244
160	119	142	150	157	179	189	199	226	160	244	251	261
180	124	149	158	166	189	200	210	239	180	259	266	277
200	130	156	165	174	199	211	222	253	200	273	282	293
220	136	163	173	183	209	222	233	266	220	288	297	309
240	141	170	181	191	219	232	245	280	240	303	313	326
260	147	177	189	200	229	243	257	293	260	318	328	342
280	152	184	197	208	239	254	268	306	280	332	344	358
300	158	191	204	217	249	265	280	320	300	347	359	374

Medidas del total del enrollable con soportes incluidos en cm. **Para medidas superiores consultar**

PANEL JAPONÉS

	60	80	100	120
100	47	51	64	70
120	50	55	69	75
140	52	58	74	81
160	55	62	79	87
180	58	65	84	93
200	60	69	89	98
220	63	72	94	104
240	66	75	99	110
260	68	79	103	116
280	71	82	108	121
300	74	86	113	127

MINITECH

	60	80	100	120
100	130	143	157	171
120	137	151	166	181
140	144	159	175	191
160	151	168	184	201
180	158	176	193	211
200	165	184	202	221

Si el ancho del enrollable es superior al ancho del tejido, deberá confeccionarse dándole la vuelta al tejido. Esto puede derivar en otro método de fabricación. Si dándole la vuelta al tejido no se cubre el alto deseado, se empalmará el tejido (horizontalmente y en la parte superior). Dar la vuelta al tejido puede provocar aguas y los laterales del tejido del enrollable extendido pueden deformarse hacia adelante o hacia atrás, no siendo este motivo de reclamación. Para todos estos casos, se entenderá que el cliente final ha sido informado y que se tiene su **autorización expresa** para la fabricación.



Enrollable / Lama Panel / Minittech

Composición y medidas (pg. TEJIDOS)

Grupo 3

P1000 Opac 400 Blackout 300 Ibiza 335	Abudhabi Luanda Rabat Qatar	Buenos Aires Mumbai Rio de Janeiro Zurich
--	--	--

ENROLLABLE Desmultiplicador 4,5 Kg

Tubo de Ø 43 mm									48 Ø mm Reforzado			
	100	120	140	160	180	200	220	240		260	280	300
100	106	117	139	145	171	178	185	191	100	208	217	230
120	113	126	149	157	185	193	200	207	120	227	236	251
140	121	134	160	168	199	208	216	224	140	245	256	272
160	128	142	170	180	213	223	232	240	160	264	275	293
180	135	151	181	191	227	238	248	257	180	282	295	314
200	142	159	191	202	241	253	264	274	200	301	314	335
220	149	168	201	214	255	267	279	290	220	319	334	356
240	157	176	212	225	269	282	295	307	240	338	353	377
260	164	185	222	237	283	297	311	323	260	356	373	398
280	171	193	233	248	296	312	327	340	280	375	392	419
300	178	201	243	259	310	327	342	357	300	393	412	441

Medidas del total del enrollable con soportes incluidos en cm. **Para medidas superiores consultar**

PANEL JAPONÉS

	60	80	100	120
100	49	55	73	79
120	52	59	79	87
140	56	64	85	95
160	59	68	92	102
180	63	72	98	110
200	66	77	105	117
220	70	81	111	125
240	73	85	118	133
260	76	90	124	140
280	80	94	130	148
300	83	99	137	155

MINITECH

	60	80	100	120
100	127	140	153	166
120	134	148	162	176
140	141	155	170	185
160	147	163	179	194
180	154	170	187	203
200	160	178	195	213

Si el ancho del enrollable es superior al ancho del tejido, deberá confeccionarse dándole la vuelta al tejido. Esto puede derivar en otro método de fabricación. Si dándole la vuelta al tejido no se cubre el alto deseado, se empalmará el tejido (horizontalmente y en la parte superior).

Dar la vuelta al tejido puede provocar aguas y los laterales del tejido del enrollable extendido pueden deformarse hacia delante o hacia atrás, no siendo este motivo de reclamación. Para todos estos casos, se entenderá que el cliente final ha sido informado y que se tiene su **autorización expresa** para la fabricación.

Enrollable / Lama Panel / Minittech



Composición y medidas(pg. TEJIDOS)

Grupo 4

Nairobi	Ibiza 380	Opaco Orient	P2000
New York	Cristal	Lino 500	
Viena	Delhi	Lino Print	

ENROLLABLE Desmultiplicador 4,5 Kg

Tubo de Ø 43 mm

48 Ø mm Reforzado

	100	120	140	160	180	200	220	240		260	280	300
100	118	130	157	163	195	203	211	216	100	233	245	263
120	126	140	169	176	211	221	230	236	120	255	268	288
140	135	150	181	190	228	239	249	255	140	276	291	313
160	143	159	194	203	244	256	268	275	160	298	314	338
180	151	169	206	216	261	274	286	295	180	319	337	363
200	160	179	218	229	277	291	305	314	200	341	360	388
220	168	189	231	243	294	309	324	334	220	362	383	413
240	176	198	243	256	310	327	343	353	240	384	406	438
260	185	208	255	269	326	344	361	373	260	405	429	463
280	193	218	268	283	343	362	380	392	280	427	452	488
300	201	228	280	296	359	380	399	412	300	448	475	513

Medidas del total del enrollable con soportes incluidos en cm. **Para medidas superiores consultar**

PANEL JAPONÉS

	60	80	100	120
100	50	60	79	89
120	54	65	87	98
140	58	70	94	107
160	61	75	101	116
180	65	80	108	125
200	69	85	116	134
220	72	90	123	142
240	76	95	130	151
260	80	100	138	160
280	83	105	145	169
300	87	111	152	178

Si el ancho del enrollable es superior al ancho del tejido, deberá confeccionarse dándole la vuelta al tejido. Esto puede derivar en otro método de fabricación. Si dándole la vuelta al tejido no se cubre el alto deseado, se empalmará el tejido (horizontalmente y en la parte superior).

Dar la vuelta al tejido puede provocar aguas y los laterales del tejido del enrollable extendido pueden deformarse hacia delante o hacia atrás, no siendo este motivo de reclamación. Para todos estos casos, se entenderá que el cliente final ha sido informado y que se tiene su **autorización expresa** para la fabricación.



Enrollable / Lama Panel / Minittech

Ibiza 380 Bicolor
Shangai
Toledo

St.Tropez
Venecia

Grupo 5

Composición y medidas(pg. TEJIDOS)

ENROLLABLE Desmultiplicador 4,5 Kg

Tubo de Ø 43 mm									48 Ø mm Reforzado			
	100	120	140	160	180	200	220	240		260	280	300
100	122	138	166	173	209	219	225	227	100	252	266	283
120	132	150	181	189	230	241	248	251	120	279	295	314
140	143	162	197	206	250	263	271	275	140	306	324	345
160	153	174	212	222	271	285	294	299	160	333	352	376
180	164	187	228	239	292	307	318	323	180	360	381	407
200	174	199	243	256	312	329	341	347	200	387	410	438
220	184	211	258	272	333	351	364	371	220	414	439	469
240	195	224	274	289	354	374	387	394	240	441	468	500
260	205	236	289	306	375	396	411	418	260	468	496	531
280	215	248	305	322	395	418	434	442	280	495	525	562
300	226	260	320	339	416	440	457	466	300	522	554	593

Medidas del total del enrollable con soportes incluidos en cm. **Para medidas superiores consultar**

PANEL JAPONÉS

	60	80	100	120
100	58	66	91	101
120	63	72	101	113
140	68	78	110	124
160	72	85	120	135
180	77	91	129	146
200	82	97	139	158
220	87	104	148	169
240	92	110	158	180
260	97	116	167	191
280	102	123	177	203
300	107	129	187	214

Si el ancho del enrollable es superior al ancho del tejido, deberá confeccionarse dándole la vuelta al tejido. Esto puede derivar en otro método de fabricación. Si dándole la vuelta al tejido no se cubre el alto deseado, se empalmará el tejido (horizontalmente y en la parte superior).

Dar la vuelta al tejido puede provocar aguas y los laterales del tejido del enrollable extendido pueden deformarse hacia delante o hacia atrás, no siendo este motivo de reclamación. Para todos estos casos, se entenderá que el cliente final ha sido informado y que se tiene su **autorización expresa** para la fabricación.

Enrollable / Lama Panel / Minittech



Grupo 6

Composición y medidas(pg. TEJIDOS)

Amsterdan	Porto Moscú
Berlín	
Budapest	

ENROLLABLE Desmultiplicador 4,5 Kg

Tubo de Ø 43 mm									48 Ø mm Reforzado			
	100	120	140	160	180	200	220	240		260	280	300
100	134	147	165	179	198	212	233	247	100	269	284	306
120	146	162	182	198	220	236	259	276	120	300	317	343
140	159	176	199	217	241	260	285	304	140	331	351	379
160	172	191	216	236	263	283	312	333	160	363	384	416
180	184	206	233	255	285	307	338	361	180	394	418	453
200	197	220	250	274	306	331	365	390	200	426	452	489
220	210	235	267	293	328	354	391	418	220	457	485	526
240	222	249	284	312	349	378	417	447	240	488	519	563
260	235	264	301	331	371	402	444	475	260	520	552	599
280	248	279	318	350	392	425	470	504	280	551	586	636
300	260	293	335	369	414	449	496	532	300	583	619	672

Medidas del total del enrollable con soportes incluidos en cm. Para medidas superiores consultar

PANEL JAPONÉS

	60	80	100	120
100	64	74	89	100
120	70	82	100	112
140	76	89	110	124
160	82	97	120	136
180	88	105	130	148
200	94	113	140	160
220	100	120	150	171
240	106	128	160	183
260	112	136	170	195
280	118	143	180	207
300	124	151	190	219

Si el ancho del enrollable es superior al ancho del tejido, deberá confeccionarse dándole la vuelta al tejido. Esto puede derivar en otro método de fabricación. Si dándole la vuelta al tejido no se cubre el alto deseado, se empalmará el tejido (horizontalmente y en la parte superior).

Dar la vuelta al tejido puede provocar aguas y los laterales del tejido del enrollable extendido pueden deformarse hacia delante o hacia atrás, no siendo este motivo de reclamación. Para todos estos casos, se entenderá que el cliente final ha sido informado y que se tiene su **autorización expresa** para la fabricación.

Enrollable / Lama Panel / Minittech



Grupo 7

SUECIA

Composición y medidas (pg. TEJIDOS)

ENROLLABLE Desmultiplicador 4,5 Kg

	Tubo de Ø 43 mm								Tubo de Ø 43 mm Reforzado			
	60	80	100	120	140	160	180	200	225	250	275	300
100	109	121	142	185	209	234	252	328	353	380	429	438
125	125	138	164	210	240	269	290	381	406	436	487	496
150	140	156	185	235	271	305	327	433	458	492	545	554
175	156	173	206	260	302	340	364	486	510	548	603	612
200	171	190	227	285	332	375	401	539	562	604	661	670
225	187	208	249	311	363	411	439	591	615	660	719	728
250	202	225	270	336	394	446	476	644	667	716	777	786
275	218	243	291	361	425	482	513	697	719	772	835	844
300	233	260	312	386	455	517	550	749	771	828	893	902
325	249	277	334	411	486	552	588	802	823	884	951	960
350	264	295	355	436	517	588	625	855	876	940	1009	1018
375	280	312	376	461	548	623	662	907	928	997	1067	1076
400	295	330	398	487	578	658	699	960	980	1053	1125	1134

Medidas del total del enrollable con soportes incluidos en cm. Para medidas superiores consultar

Tubo de Ø 48 mm Reforzado

PANEL JAPONÉS

	50	60	70	80	90	100
100	53	59	68	77	85	94
125	64	72	82	93	103	113
150	76	85	97	109	121	133
175	87	98	111	125	139	152
200	98	110	126	141	157	172
225	109	123	140	157	175	191
250	121	136	154	173	193	211
275	132	149	169	189	210	230
300	143	162	183	205	228	250
325	154	175	198	221	246	269
350	166	187	212	237	264	289

MINITECH

	50	75	100	120
75	102	127	151	171
100	120	150	180	204
125	135	170	205	233
150	150	191	231	263
175	168	214	259	296

Si el ancho del enrollable es superior al ancho del tejido, deberá confeccionarse dándole la vuelta al tejido. Esto puede derivar en otro método de fabricación. Si dándole la vuelta al tejido no se cubre el alto deseado, se empalmará el tejido (horizontalmente y en la parte superior).

Dar la vuelta al tejido puede provocar aguas y los laterales del tejido del enrollable extendido pueden deformarse hacia delante o hacia atrás, no siendo este motivo de reclamación. Para todos estos casos, se entenderá que el cliente final ha sido informado y que se tiene su **autorización expresa** para la fabricación.



Impresión Digital

LINK



Impresión Digital

		Incremento / €
516401	Impresión m ²	26
516402	Retoque fotográfico	25
516403	Compra de Imagen	35



Ejemplo de Enrollable Impreso

Enrollable 43Ø P1000 160x225	193
Impresión 160x125 = (2x00)	52
Total	245

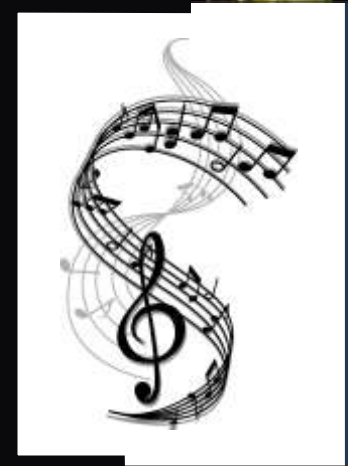
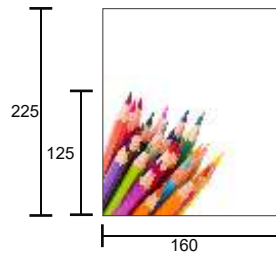



Opciones

CONFECCIÓN

Suplemento en €

516501	Doble bolsa (arriba y abajo)	30
516502	Doble velcro (arriba y abajo)	30
516503	Empalme tejido	15
516504	Arreglo enrollable	38
516505	Cortado a medida y escuadrado	25
516506	Cortado forma especial	42

MANIVELA

Suplemento en €

516106	Tubo 43mmØ	129
516107	Tubo 54mmØ y 58mmØ	150

GUIADO CABLE

Suplemento en €

516108	25mmØ-43mmØ	34
516109	50mmØ-70mmØ Interior	94
516110	50mmØ-70mmØ Exterior	249

CADENA METÁLICA (Alto cadena)

En €

	REF.	100	140	180	220	260	300	340
Cromo	516101	5.74	6.58	7.56	8.40	9.38	10.22	11.20

CAJÓN ALUMINIO (77mm/92mm)

En €

	REF.	100	140	180	220	260	300	320	360
77 mm	516102	130	150	171	196	217	-	-	-
92 mm	516103	133	153	175	200	221	244	260	281

GUÍAS (Laterales o frontales)

En €

	REF.	100	140	180	220	260	300	320	360	400
Lateral	516104	45	55	66	80	92	104	108	119	130
Frontal	516105	69	88	109	133	154	175	185	206	252

Motorización ENROLLABLES



MOTORES RIELES VALENCIANOS A-OK

REF.	DETALLE	PVP (En €)
516201	Motor mecánico 43-48mmØ	107
516202	Motor mecánico 58mmØ	107
516203	Motor Vía Radio 43-48mmØ	198
516204	Motor Vía Radio 58mmØ	198
516205	Mando 1 canal	40
516206	Mando 6 canales	54
516207	Mando 16 canales	89
516208	Motor Batería	283
516209	Cargador	46
516210	Controlador domótica con App y comp. Alexa y Google	217

MOTORES somfy

REF.	DETALLE	PVP (En €)
516301	Motor mecánico 43-48mmØ Ls40 WT 3/30	273
516302	Motor mecánico 58mmØ Lt50 ARIANE 6/32	318
516303	Motor Vía Radio IO 43-48mmØ SUNEASCR 40 IO 3/30	444
516304	Motor Vía Radio IO 58mmØSUNEASCREEN 50 6/32	444
516305	Mando IO 1 canal SITUO 1 IO PURE	119
616306	Mando IO 5 canales SITUO 5 IO PURE	190
616307	Pulsador pared IO 1 canal SMOOVE ORIGIN IO	113
616308	Pulsador pared IO 2 canales SMOOVE ORIGIN 2 IO	132
616309	Pulsador pared IO 4 canales SMOOVE ORIGIN 4 IO	182
616310	Motor Batería SONESSE ULTRA 30 RTS LI-ION	340
616311	Cargador SONESSE 30 RTS LI-ION	27
616312	Mando motor batería SITUO RTS	56
616313	Controlador domótica CONNEXXOON IO	242
616314	Controlador domótica TAHOMA	710



Tejidos

CARACTERISTICAS DE LOS TEJIDOS

GRUPO	TEJIDO	DEC	FR	ANCHO cm	GR/m ²	ABERTURA	COMPOSICIÓN
G1	Loneta resinada blanca			300	180	Traslucido	pvc/poliéster
	Loneta resinada colores			200	180	Traslucido	pvc/poliéster
	Shantung			200	190	Traslucido	pvc/poliéster
G2	P3000		X	320	415	5%	pvc/poliéster
	P10		X	320	370	1%	pvc/poliéster
G3	Abu Dhabi		X	300	458	4%	24% poliéster 76% pvc
	Luanda		X	300	443	4%	24% poliéster 76% pvc
	Rabat		X	300	435	4%	24% poliéster 76% pvc
	Qatar		X	300	431	4%	24% poliéster 76% pvc
	Opac-400		X	200	400	Opaco	67% pvc 33% f.vidrio
	P1000		X	320	490	1%	pvc/poliéster
	Beigin Opac			300	398	Opaco	100% poliéster
	Blackout 300			300	530	Opaco	100% poliéster
	Ibiza 335		X	320	340	1%	67% pvc 33% f.vidrio
	Buenos Aires	X		195	170	Traslucido	100% poliéster
	Mumbai	X		200	165	Traslucido	100% poliéster
Rio de Janeiro	X		200	165	Traslucido	100% poliéster	
Zurich	X		195	170	Traslucido	100% poliéster	
G4	Ibiza 380		X	320	380	5%	64% pvc 36% f.vidrio
	Cristal		X	300	395	5%	78% pvc 22% f.vidrio
	Delhi	X		200	190	Traslucido	100% poliéster
	Bali Opac			300	305	Opaco	100% poliéster
	Nairobi	X		200	145	Traslucido	100% poliéster
	New York	X		200	145	Traslucido	100% poliéster
	Viena	X		200	190	Traslucido	100% poliéster
G5	Bicolor Ibiza 380		X	250	380	5%	64% pvc 36% f.vidrio
	Bicolor N-203		X	320	420	3%	64% pvc 36% f.vidrio
	Shangai	X		200	305	Traslucido	100% poliéster
	Saint Tropez	X		200	305	Traslucido	100% poliéster
	Venecia	X		200	200	Traslucido	100% poliéster
G6	Amsterdam	X		200	210	Traslucido	100% poliéster
	Berlín	X		200	130	Traslucido	100% poliéster
	Budapest	X		200	200	Traslucido	100% poliéster
	Moscú	X		240	185	Traslucido	100% poliéster

DEC (Decorativos) = X

FR (Ignifugos) = X

Noche y Día



	80	120	160	200	240	180	260	220	300
100	101	149	188	206	245	199	284	241	380
140	117	177	224	247	296	239	344	290	448
180	133	204	261	289	347	279	403	340	517
220	149	232	298	331	398	318	463	389	586
260	166	260	335	373	449	358	523	439	655
300	182	287	372	415	500	398	583	488	724
240	158	246	316	352	424	338	493	414	620
	80	120	160	200	240	180	260	220	300



CARTA DE COLORES



Ventex



	80	120	160	200	225	250	275
100	101	140	178	216	241	264	297
150	124	174	222	269	301	331	374
200	147	207	265	323	361	398	451
250	171	241	309	377	422	464	528
300	194	274	352	431	482	531	605
350	217	307	396	485	542	598	682
400	240	341	440	539	602	664	759
	80	120	160	200	225	250	275



Impresión Digital (consultar).



Verticales

(Tejido noche y día)





Verticales

NOCHE Y DÍA

MODELO VENUS

En €

	100	120	140	160	180	200	220	240	260	280	300	320	340	360	380	400	
100	133	161	175	200	219	244	260	288	313	340	357	382	407	416	431	454	100
125	150	182	197	227	249	278	298	327	357	387	408	435	465	477	496	523	120
150	167	203	220	254	279	311	335	367	400	435	458	488	522	538	561	591	140
175	184	224	242	280	308	345	373	406	444	482	509	542	579	599	626	660	160
200	201	245	265	307	338	379	410	446	487	530	560	595	637	661	691	728	180
225	218	266	287	334	368	412	448	486	531	577	611	649	694	722	756	797	200
250	235	288	310	360	398	446	486	525	575	625	662	702	752	783	821	865	220
275	252	309	332	387	427	480	523	565	618	672	713	756	809	844	886	934	240
300	269	330	355	413	457	513	561	604	662	720	763	809	866	905	951	1002	260
325	286	351	377	440	487	547	598	644	705	767	814	862	924	966	1016	1071	280
350	303	372	400	467	516	581	636	683	749	815	865	916	981	1028	1081	1139	300
	100	120	140	160	180	200	220	240	260	280	300	320	340	360	380	400	

MODELO MERCURIO

En €

	100	120	140	160	180	200	220	240	260	280	300	320	340	360	380	400	
100	142	172	186	214	235	261	280	308	336	364	382	409	437	448	465	491	100
125	162	196	212	245	269	300	323	354	386	419	441	471	503	518	541	571	120
150	181	221	238	276	303	339	367	400	436	474	500	533	570	589	616	650	140
175	201	245	264	307	338	378	410	445	487	529	559	595	636	660	691	729	160
200	220	270	291	337	372	417	454	491	537	584	617	656	702	730	766	808	180
225	240	294	317	368	406	456	497	537	588	639	676	718	769	801	841	887	200
250	260	319	343	399	441	495	541	583	638	694	735	780	835	872	916	967	220
275	279	343	369	430	475	534	584	628	688	749	794	842	902	942	991	1046	240
300	299	368	395	461	509	573	628	674	739	804	853	904	968	1013	1066	1125	260
325	319	392	421	492	544	612	671	720	789	859	912	965	1034	1084	1141	1204	280
350	338	417	447	522	578	651	715	766	839	914	970	1027	1101	1154	1216	1284	300
	100	120	140	160	180	200	220	240	260	280	300	320	340	360	380	400	

EL ANCHO PEDIDO ES EL ANCHO TOTAL DEL MECANISMO, EL TEJIDO OCUPARA 6,5 cm MENOS A CADA EXTREMO DEL MECANISMO.

COLORIDO PERFIL: BLANCO, PLATA Y NEGRO

COLORIDO PERFIL: BRONCE LACADO SUPLEMENTO 15,45€ M/LINEAL DEL MECANISMO

ACCIONAMIENTO MANUAL Y CORDÓN-CADENA

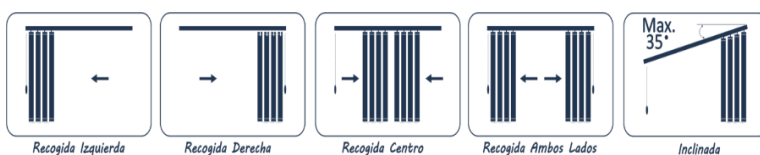

PVP IVA no incluido



Verticales





Verticales



Mecanismo Lama 89 mm

							En €
100	150	200	250	300	350	400	
65	76	89	99	110	123	134	

Mecanismo Lama 127 mm

							En €
100	150	200	250	300	350	400	
63	72	84	93	103	115	124	

Verticales



CORTINA VERTICAL 89 mm

Loneta Resinada y Shantung

laminas	14	17	20	23	27	30	33	37	40	43	47	50	53	
	100	125	150	175	200	225	250	275	300	325	350	375	400	
100	93	110	126	142	161	177	193	212	230	246	265	281	298	100
125	98	116	134	151	172	189	206	226	246	263	283	301	319	125
150	104	123	141	160	182	201	219	241	262	280	302	321	340	150
175	109	130	149	169	193	213	232	256	278	297	321	340	361	175
200	114	136	157	178	204	225	246	270	293	314	339	360	382	200
225	120	143	165	187	214	236	259	285	309	331	358	380	403	225
250	125	149	173	196	225	248	272	300	325	348	376	400	424	250
275	131	156	181	205	236	260	285	314	341	366	395	420	445	275
300	136	163	189	214	246	272	298	329	357	383	414	439	466	300
325	142	169	196	223	257	284	311	344	373	400	432	459	487	325
350	147	176	204	232	268	296	324	358	388	417	451	479	508	350
375	153	183	212	241	278	307	337	373	404	434	470	499	529	375
400	158	189	220	250	289	319	350	387	420	451	488	519	550	400
	100	125	150	175	200	225	250	275	300	325	350	375	400	

BLACKOUT-300

laminas	14	17	20	23	27	30	33	37	40	43	47	50	53	
	100	125	150	175	200	225	250	275	300	325	350	375	400	
100	112	133	162	174	199	219	239	263	286	306	330	351	372	100
125	123	146	179	193	221	244	267	294	319	342	369	392	415	125
150	134	159	196	212	243	268	294	324	352	377	407	433	459	150
175	145	173	213	231	265	293	321	354	384	412	446	474	502	175
200	155	186	229	250	287	318	348	385	417	447	484	515	546	200
225	166	199	246	269	310	342	375	415	450	483	523	556	589	225
250	177	212	263	287	332	367	402	445	483	518	562	597	633	250
275	188	225	280	306	354	391	429	476	516	553	600	638	676	275
300	198	238	296	325	376	416	456	506	548	589	639	679	719	300
325	209	251	313	344	398	441	483	536	581	624	677	720	763	325
350	220	264	330	363	420	465	510	567	614	659	716	761	806	350
375	231	277	347	382	442	490	537	597	647	694	754	802	850	375
400	241	290	363	401	465	515	564	627	680	730	793	843	893	400
	100	125	150	175	200	225	250	275	300	325	350	375	400	

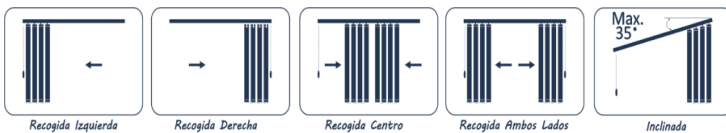

Si se desea las laminas montadas con los contrapesos y las cadenas montadas, se aplicará un suplemento de 12 €.
 En caso de laminas de color combinado, se aplicará un suplemento de 22 €.
 El número de laminas puede sufrir una variación de + - 1 lama.

PVP IVA no incluido



Verticales

CORTINA VERTICAL 89 mm

P-3000 SCREEN 5%

laminas	14	17	20	23	27	30	33	37	40	43	47	50	53	
	100	125	150	175	200	225	250	275	300	325	350	375	400	
100	133	153	189	201	229	253	276	304	330	354	382	405	430	100
125	150	174	213	228	263	290	317	350	380	407	440	467	495	125
150	166	194	237	256	297	328	359	396	430	461	498	529	561	150
175	183	215	261	283	330	365	400	442	480	514	557	592	627	175
200	199	235	285	311	364	402	441	488	529	568	615	654	693	200
225	216	256	309	338	398	440	482	534	579	621	674	716	759	225
250	232	276	333	366	431	477	523	580	629	675	732	778	825	250
275	249	296	358	393	465	515	564	626	679	728	790	840	890	275
300	265	317	382	421	499	552	605	672	729	782	849	902	956	300
325	282	337	406	448	533	590	647	718	778	835	907	964	1022	325
350	298	358	430	476	566	627	688	764	828	889	966	1026	1088	350
375	315	378	454	503	600	664	729	810	878	942	1024	1088	1154	375
400	331	399	478	531	634	702	770	856	928	996	1082	1150	1220	400
	100	125	150	175	200	225	250	275	300	325	350	375	400	

P-1000 SCREEN 1%

laminas	14	17	20	23	27	30	33	37	40	43	47	50	53	
	100	125	150	175	200	225	250	275	300	325	350	375	400	
100	163	189	233	248	285	315	345	381	413	443	479	509	539	100
125	183	213	261	281	324	358	392	434	471	505	547	581	616	125
150	203	238	288	315	363	402	440	488	529	567	615	653	693	150
175	223	263	316	348	402	445	488	541	587	629	683	726	769	175
200	243	287	344	381	441	489	536	595	645	692	751	798	846	200
225	263	312	372	415	481	532	583	648	702	754	819	870	923	225
250	282	336	399	448	520	575	631	702	760	816	887	943	999	250
275	302	361	427	481	559	619	679	755	818	878	955	1015	1076	275
300	322	386	455	515	598	662	727	809	876	941	1023	1087	1153	300
325	342	410	483	548	637	706	774	863	934	1003	1091	1160	1229	325
350	362	435	511	581	676	749	822	916	992	1065	1159	1232	1306	350
375	382	460	538	615	715	793	870	970	1050	1127	1227	1304	1383	375
400	402	484	566	648	754	836	918	1023	1108	1189	1295	1377	1459	400
	100	125	150	175	200	225	250	275	300	325	350	375	400	

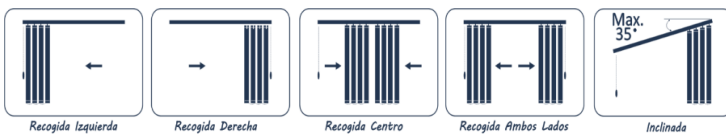

Si se desea las lamas montadas con los contrapesos y las cadenas montadas, se aplicará un suplemento de 12 €.
 En caso de lamas de color combinado, se aplicará un suplemento de 22.
 El número de lamas puede sufrir una variación de + - 1 lama.

Verticales



CORTINA VERTICAL 127 mm

Loneta Resinada y Shantung

laminas	9	11	13	15	18	20	22	24	26	29	31	33	35	
	100	125	150	175	200	225	250	275	300	325	350	375	400	
100	83	98	114	128	146	160	166	190	205	223	237	251	266	100
125	88	104	121	136	155	170	177	202	218	239	254	269	285	125
150	93	110	127	144	165	181	189	215	232	254	270	287	304	150
175	97	115	134	152	174	192	201	228	246	270	287	304	322	175
200	102	121	141	160	184	202	213	241	260	285	304	322	341	200
225	107	127	148	168	193	213	224	254	274	301	320	340	360	225
250	111	133	155	175	203	224	236	266	288	316	337	357	379	250
275	116	139	162	183	213	234	248	279	302	332	353	375	397	275
300	121	144	169	191	222	245	260	292	315	347	370	393	416	300
325	126	150	175	199	232	256	271	305	329	363	386	410	435	325
350	130	156	182	207	241	266	283	317	343	378	403	428	453	350
375	135	162	189	215	251	277	295	330	357	393	419	445	472	375
400	140	167	196	223	260	287	307	343	371	409	436	463	491	400
	100	125	150	175	200	225	250	275	300	325	350	375	400	

BLACKOUT-300

laminas	9	11	13	15	18	20	22	24	26	29	31	33	35	
	100	125	150	175	200	225	250	275	300	325	350	375	400	
100	103	123	143	161	186	205	227	243	263	288	307	325	345	100
125	113	135	158	179	207	228	253	272	294	322	343	364	386	125
150	123	147	174	197	229	252	278	300	324	357	380	404	428	150
175	133	159	189	215	250	276	304	329	355	391	417	443	469	175
200	143	172	205	233	271	299	330	357	386	426	454	482	511	200
225	153	184	220	251	293	323	356	386	417	460	490	521	552	225
250	163	196	236	268	314	347	382	414	448	494	527	560	594	250
275	173	208	251	286	335	371	408	443	479	529	564	599	635	275
300	183	221	266	304	357	394	434	471	509	563	601	638	677	300
325	193	233	282	322	378	418	459	500	540	598	637	677	718	325
350	203	245	297	340	400	442	485	528	571	632	674	716	760	350
375	214	257	313	357	421	466	511	557	602	666	711	756	801	375
400	224	270	328	375	442	489	537	585	633	701	748	795	842	400
	100	125	150	175	200	225	250	275	300	325	350	375	400	

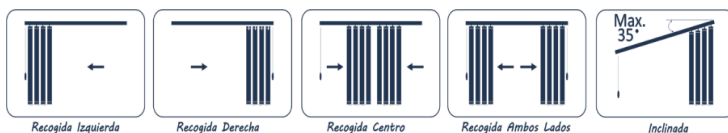

Si se desea las laminas montadas con los contrapesos y las cadenas montadas, se aplicará un suplemento de 12 €.
 En caso de laminas de color combinado, se aplicará un suplemento de 22 €.
 El número de laminas puede sufrir una variación de + - 1 lama.



Verticales

CORTINA VERTICAL 127 mm

P-3000 SCREEN 5%

laminas	9	11	13	15	18	20	22	24	26	29	31	33	35	
	100	125	150	175	200	225	250	275	300	325	350	375	400	
100	118	140	163	184	212	233	254	278	300	329	350	372	394	100
125	131	157	183	207	240	264	287	315	340	373	398	422	447	125
150	145	174	203	230	267	295	320	351	380	418	445	473	501	150
175	159	190	223	253	295	325	352	388	419	462	493	523	554	175
200	173	207	243	276	323	356	385	425	459	507	540	574	608	200
225	187	224	263	299	350	387	418	462	499	551	587	624	661	225
250	201	241	283	322	378	417	451	498	539	595	635	674	715	250
275	215	258	303	345	405	448	484	535	579	640	682	725	768	275
300	229	275	323	369	433	479	517	572	619	684	730	775	822	300
325	243	292	343	392	461	509	550	609	658	728	777	826	875	325
350	256	309	363	415	488	540	583	646	698	773	825	876	929	350
375	270	326	383	438	516	571	616	682	738	817	872	927	983	375
400	284	343	403	461	543	601	649	719	778	862	919	977	1036	400
	100	125	150	175	200	225	250	275	300	325	350	375	400	

P-1000 SCREEN 1%

laminas	9	11	13	15	18	20	22	24	26	29	31	33	35	
	100	125	150	175	200	225	250	275	300	325	350	375	400	
100	145	173	202	229	266	293	322	350	378	416	443	471	499	100
125	165	198	231	263	307	339	371	404	437	482	514	546	578	125
150	186	223	261	297	348	384	420	459	496	548	584	621	658	150
175	206	248	291	332	389	430	469	514	555	614	655	696	737	175
200	227	273	320	366	430	476	518	568	615	680	725	771	817	200
225	247	298	350	400	471	521	567	623	674	746	796	846	896	225
250	268	323	380	434	512	567	616	677	733	812	866	921	976	250
275	289	349	409	469	553	612	666	732	792	878	937	996	1055	275
300	309	374	439	503	594	658	715	787	851	943	1007	1071	1135	300
325	330	399	469	537	635	703	764	841	910	1009	1077	1146	1215	325
350	350	424	498	571	676	749	813	896	969	1075	1148	1220	1294	350
375	371	449	528	605	717	794	862	950	1028	1141	1218	1295	1374	375
400	392	474	558	640	758	840	911	1005	1088	1207	1289	1370	1453	400
	100	125	150	175	200	225	250	275	300	325	350	375	400	

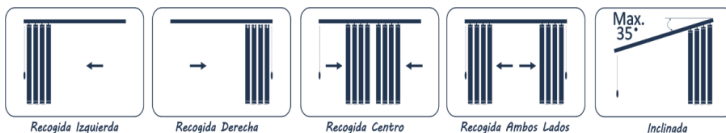

Si se desea las lamas montadas con los contrapesos y las cadenas montadas, se aplicará un suplemento de 12 €. En caso de lamas de color combinado, se aplicará un suplemento de 22. El número de lamas puede sufrir una variación de +- 1 lama.



Verticales Impresión Digital





Impresión Digital

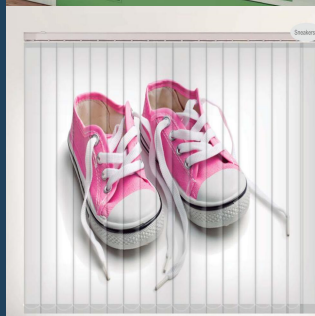
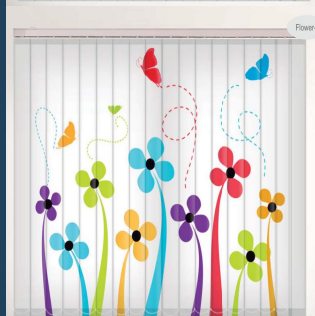
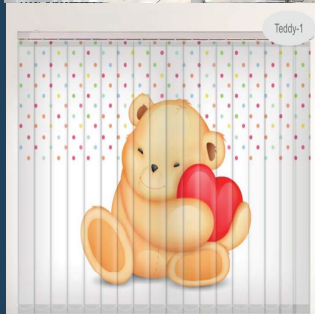

Impresión Digital

		Incremento / €
516404	Impresión m ²	75.60 m
516402	Retoque fotográfico	25
516403	Compra de Imagen	35

Ejemplo de Vertical Impresa

Vertical 127mm P1000 160x225
Impresión 140x225 = 2.1m
Total

	400
	238.14
	638

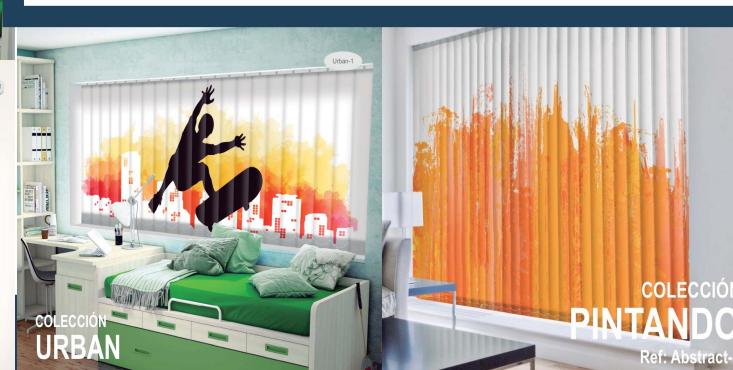
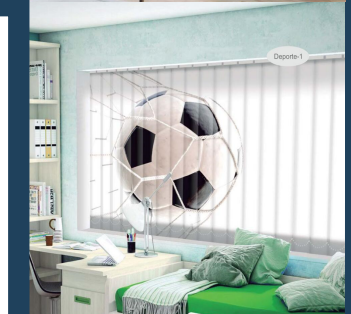



Mosquiteras





Mosquiteras

MOSQUITERO ENROLLABLE (cajón de 42 mm)



Sistema de reducción de velocidad

Incremento de 7 € la unidad

	En €													
	50	60	70	80	90	100	110	120	130	140	150	160	170	180
100	34	36	39	42	44	47	50	52	55	58	61	63	66	69
120	36	38	41	44	47	49	52	55	57	60	63	65	68	71
140	38	41	43	46	49	51	54	57	59	62	65	68	70	73
160	40	43	45	48	51	54	56	59	62	64	67	70	72	75
180	44	46	49	52	55	57	60	63	65	68	71	73	76	79
200	46	49	51	54	57	59	62	65	67	70	73	76	78	81
220	48	51	53	56	59	62	64	67	70	72	75	78	80	83
240	50	53	56	58	61	64	66	69	72	74	77	80	83	85

ACABADOS

Blanco	Precio Tarifa
Plata	Incremento 5 %
Bronce, Inox, y carta de colores	Incremento 15 %

1015 MARFIL	6005 VERDE MUSGO	6009 VERDE PINO	3005 ROJO VINO	8019 MARRÓN GRIS	8014 MARRÓN SEPIA	8007 MARRÓN	8017 MARRÓN CHOCOLATE
7016 GRIS ANTRACITA	7011 GRIS ACERO	7022 GRIS TIERRA	5013 AZUL COBALTO	9011 NEGRO GRAFITO	9005 NEGRO		

Mosquiteras



MOSQUITERO CORREDERO Y FIJO - ABATIBLE

CORREDERA FIJA

	En €						
	60	80	100	120	140	160	180
60	32	35	37	40	43	46	48
80	35	38	40	43	46	49	52
100	37	40	43	46	49	52	55
120	40	43	46	49	52	55	58
140	43	46	49	52	55	58	61
160	46	49	52	55	58	61	65
180	53	58	62	66	70	74	78
200	56	60	64	69	73	77	81
220	59	63	67	72	76	80	84
240	62	66	70	75	79	83	88



MOSQUITERA ABATIBLE

	En €						
	60	70	80	90	100	110	120
180	250	252	256	262	268	271	273
190	254	256	259	265	271	275	277
200	257	259	263	269	275	279	281
210	260	262	266	273	279	283	285
220	264	266	270	276	283	287	289
230	268	270	274	280	287	291	293
240	271	273	278	284	290	295	297
250	275	277	281	288	294	299	301



OPCIONES

GATERA	CONSULTAR
BISAGRA CIERRE PUERTA	
RED ALUMINIO 18/16	
TRAGALUZ FIJO	
RED PETSREEN GRIS	

ACABADOS

Blanco	Precio Tarifa
Plata	Incremento 5 %
Bronce, Inox, y carta de colores	Incremento 15 %

1015 MARFIL	6005 VERDE MUSGO	6009 VERDE PINO	3005 ROJO VINO	8019 MARRÓN GRIS	8014 MARRÓN SEPIA	8007 MARRÓN	8017 MARRÓN CHOCOLATE
7016 GRIS ANTRACITA	7011 GRIS ACERO	7022 GRIS TIERRA	5013 AZUL COBALTO	9011 NEGRO GRAFITO	9005 NEGRO		



Mosquiteras

PLISSÉ 22 PUERTA



Plissé 22 es el mosquitero de fácil accionamiento para puertas y ventanas de plegado vertical más ligero y apto para espacios limitados, gracias a sus perfiles exteriores de 22 mm.

La fijación mediante clips facilita el montaje y desmontaje del sistema.

El carril inferior de apenas 7mm permite el paso sin problemas incluso carritos o sillas de discapacitados.

La tela plisada se suministra en negro, opcionalmente en gris.

Disponible en una hoja, hoja doble o modelo reversible (apertura indistinta a izquierda, derecha o ambos lados)



MEDIDAS PUERTA	SIMPLE		DOBLE
	MIN. CM	MAX. CM	MAX. CM
ANCHO (W)	-	210	280
ALTO (H)	60	260	260

MEDIDAS REVERSIBLE	MIN. CM	MAX. CM
ANCHO (W)	-	260
ALTO (H)	60	260

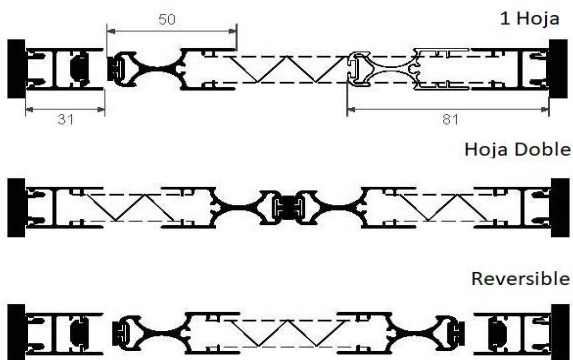



PLISSÉ 22 PUERTA

PLISSE 1 HOJA 22

	En €							
	80	100	120	140	160	180	200	220
190	193	210	219	232	246	260	274	294
200	194	209	223	236	250	264	278	298
210	201	213	227	240	254	268	282	302
220	205	217	231	244	258	272	285	305
230	209	220	235	248	262	276	290	310
240	213	225	239	252	266	280	294	314
250	249	268	289	308	329	350	371	395
260	253	272	293	313	334	355	376	399

PLISSE DOBLE 22

	En €												
	180	200	220	240	260	280	300	320	340	360	380	400	420
190	397	420	425	439	450	464	598	615	632	650	667	685	702
200	405	419	433	446	458	472	608	625	642	660	677	695	712
210	413	427	441	455	466	480	618	635	652	670	687	705	722
220	421	435	449	462	474	488	627	645	662	679	696	713	731
230	429	440	457	471	482	496	637	655	672	689	706	724	741
240	437	451	465	479	490	504	648	665	682	700	717	734	752
250	515	536	557	579	596	617	797	823	850	876	902	928	954
260	523	544	565	586	604	625	808	834	860	887	913	939	965

PLISSE REVERSIBLE 22

	En €							
	120	140	160	180	200	220	240	260
190	357	371	385	397	420	425	439	450
200	365	379	393	405	419	433	446	458
210	373	387	401	413	427	441	454	466
220	381	395	409	421	435	449	462	474
230	389	403	417	429	440	457	471	482
240	397	411	425	437	451	465	479	490
250	455	464	498	515	536	557	579	596
260	464	485	506	523	544	565	586	604

ACABADOS

Blanco	Precio Tarifa
Plata	Incremento 5 %
Bronce, Inox, y carta de colores	Incremento 15 %

1015 MARFIL	6005 VERDE MUSGO	6009 VERDE PINO	3005 ROJO VINO	8019 MARRÓN GRIS	8014 MARRÓN SEPIA	8007 MARRÓN	8017 MARRÓN CHOCOLATE
7016 GRIS ANTRACITA	7011 GRIS ACERO	7022 GRIS TIERRA	5013 AZUL COBALTO	9011 NEGRO GRAFITO	9005 NEGRO		



Mosquiteras

PLISSÉ 22 VENTANA

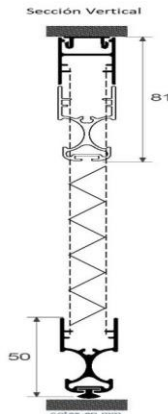

Plissé 22 Ventana es el mosquitero para ventanas de plegado horizontal más ligera y apta para espacios limitados gracias a sus perfiles exteriores de 22 mm.

Fácil de usar, instalar, desmontar y limpiar. La tela plisada se suministra en negro, opcionalmente engris. La varilla de acción es el accesorio perfecto como ayuda a la hora de cerrar o abrir el mosquitero.

MEDIDAS REVERSIBLE	MIN. CM	MAX. CM
ANCHO (W)	-	260
ALTO (H)	60	260

PLISSE VENTANA 22						
	En €					
	80	100	120	140	160	170
100	143	148	153	158	163	165
110	148	153	158	163	168	171
120	154	156	161	166	171	173
130	156	161	165	170	176	178
140	160	165	170	175	180	183
150	165	170	175	180	185	187
160	169	174	179	184	189	192
170	174	179	184	189	194	197
180	179	184	189	194	199	201
190	183	188	193	198	203	206

ACABADOS	
Blanco	Precio Tarifa
Plata	Incremento 5 %
Bronce, Inox, y carta de colores	Incremento 15 %



Mosquiteras



PLISSÉ 40



Plissé 40 es el mosquitero perfecto para puertas de frecuente paso gracias a la ausencia de barreras al suelo y su facilidad de accionamiento.. El carril superior permite un juego de hasta 30 mm.

Fácil de montar, fácil de desmontar y sencillo de limpiar. Una sola hoja puede cubrir hasta 3 metros de altura y 2 metros de ancho. Se pueden combinar varias hojas para cubrir grandes espacios. La tela plisada se suministra en negro, Opcionalmente en gris.

Accesorios opcionales:

El marco para la instalación frontal cuando no contamos con techo o paredes. Perfil XL para asegurarnos del correcto funcionamiento en zonas de viento para anchos mayores a 130 cm. Perfil compensador para salvar irregularidades en el muro pared.

MEDIDAS 40	MIN. CM	MAX. CM
ANCHO (W)	-	200
ALTO (H)	90	300

ALTURA TELA	MIN. CM	MAX. CM
NEGRA	90	300
GRIS	90	260

PLISSE 1 HOJA 40

	En €				
	100	120	140	160	180
200	280	303	326	349	374
210	286	309	332	355	379
220	293	316	339	362	386
230	331	360	388	417	448
240	360	390	422	454	488
250	366	398	430	462	496
260	373	404	436	468	503

PLISSE DOBLE 40

	200	220	240	260	280	300	320	340	360
200	442	562	587	610	633	656	679	702	727
210	450	572	597	620	643	666	689	712	737
220	461	584	609	633	656	679	701	725	750
230	522	663	695	725	752	782	810	839	871
240	567	719	754	788	818	852	882	915	951
250	577	734	769	802	833	866	897	930	965
260	586	745	780	813	844	877	908	941	976

SECCIÓN HORIZONTAL

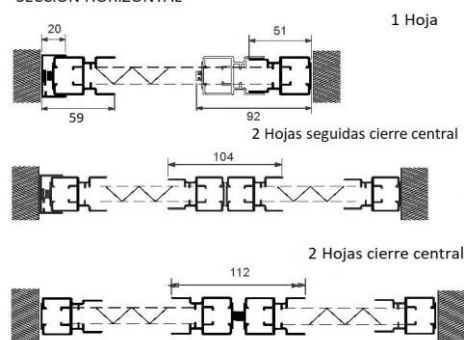



Mosquiteras

FLEXA



Elegante mosquitera enrollable lateral, ideal para puertas y ventanas; diseño ergonómico de perfil de la barra de la maneta, que hace fácil y cómodo el accionamiento tanto desde el interior como desde el exterior.

La apertura y cierre de la hoja, aun provista de muelle, resulta muy controlada, evitando movimientos imprevistos y rápidos.

Esta característica, unida a la guía de suelo muy baja, hace de éste un producto ideal para los vanos de paso frecuente (muro o pared).

Sección Horizontal

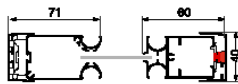

1 Hoja

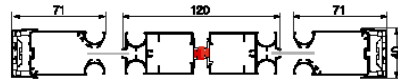

2 Hojas

MEDIDAS 40	MIN. CM	MAX. CM
ANCHO (W)	-	1400
ALTO (H)	-	500

En €

	FLEXA									
	ANCHO HOJA SIMPLE					ANCHO HOJADOBLE				
	80	100	120	140	160	180	200	240	280	300
180	257	257	278	324	371	515	515	556	649	741
190	257	257	293	342	391	515	515	587	685	782
200	257	257	309	360	412	515	515	618	721	824
210	257	270	324	378	432	515	541	649	757	865
220	257	283	340	396	453	515	566	680	793	906
230	257	296	355	414	474	515	592	710	829	947
240	257	309	371	432	494	515	618	741	865	988
250	257	322	386	450	515	515	644	772	901	1030
260	268	335	402	468	535	535	669	803	937	1071
270	278	347	417	486	556	556	695	834	973	1112
280	288	360	432	505	577	577	721	865	1009	1153
290	299	373	448	523	597	597	746	896	1045	1194

ACABADOS

Blanco	Precio Tarifa
Plata	Incremento 5 %
Bronce, Inox, y carta de colores	Incremento 15 %



TEJIDOS DECORATIVOS

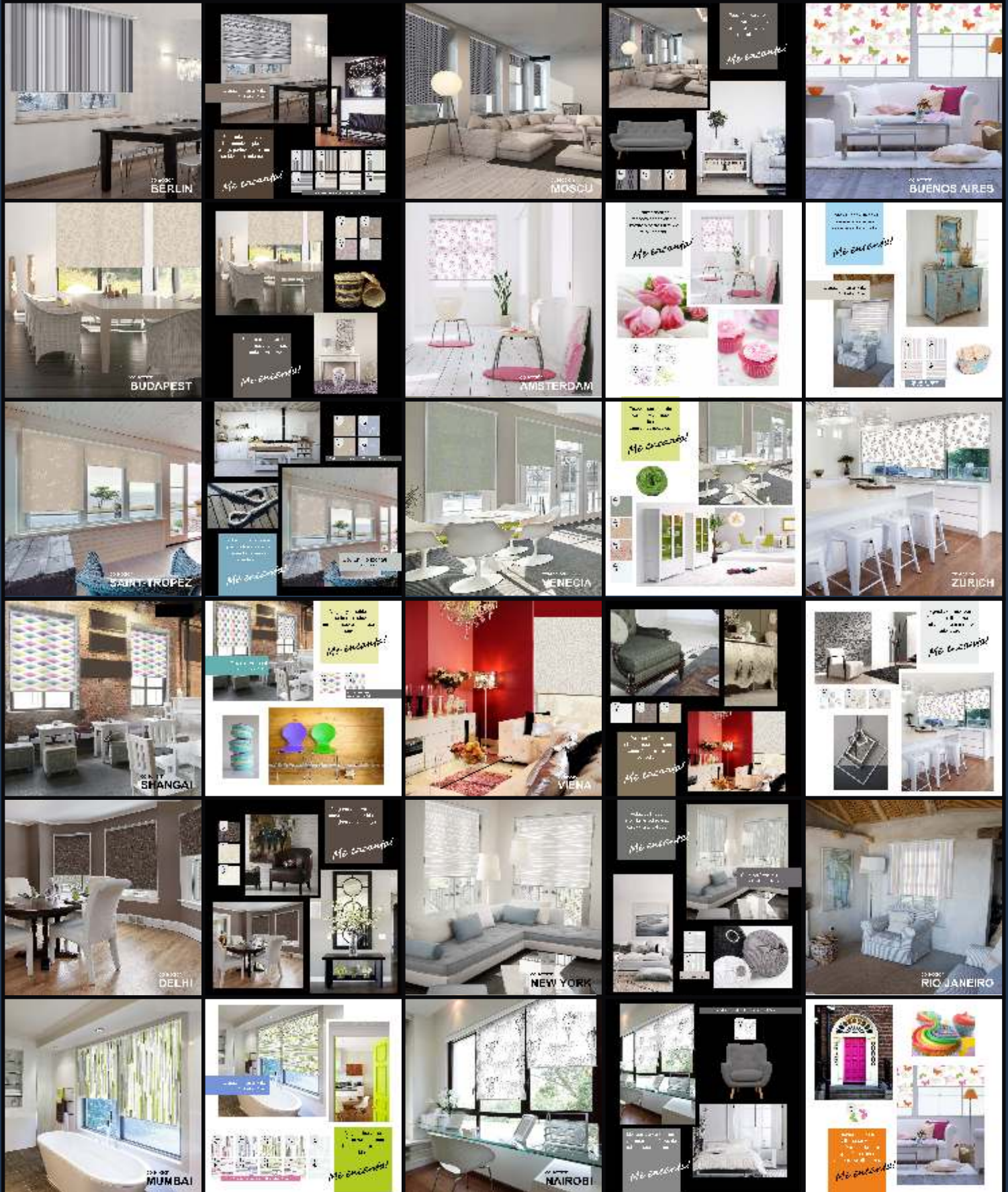



Avda. Castellón, 4 B
46210 Picaña (Valencia)
Tel. 961794004

WhatsApp



+34 642 167 903

Email: info@rielesvalencianos.com